



MEDICAL • SHIPMENT

Nursing Education Supply Experts, At Your Service



**MEDICAL SHIPMENT
PRODUCTS**
Pages 4-7



HOSPITAL BEDS
Pages 54-61



IV PUMPS
Pages 62-65



PRACTICE MEDS
Pages 178-197



ACCUVEIN
Pages 128-133



NURSING KITS
Pages 208-211



PYXIS® MEDSTATION 4000

*TRUSTED BY HOSPITALS.
NOW AVAILABLE FOR EDUCATION.*
See pages 198-201





Thank you for your continued support & customer loyalty!

MEDICAL SHIPMENT is excited to bring you our "THIRD EDITION" Catalog

From my parents' garage to now servicing North America and growing worldwide, the heart of this company is YOU, OUR CUSTOMER!

Medical Shipment started with a few bucks in my back pocket, the support of my family, and the mentorship of a nurse educator. The guidance and insight from the nurse educator opened my eyes to the world of nursing education.

Nurses play a vital role in the future of all of our lives. The dedication and hard work that it takes to be a nurse is awe-inspiring. By offering state-of-the-art tools, product insight, and time-saving shopping, Medical Shipment allows future nurse to focus on their education.

We have an exclusive distributorship of the PYXIS® in the educational marketplace, and an exclusive partnership with Accuvein®, the leader in vein visualization. New items currently added to our extensive range of products include: Medical Shipment's Private Label Products, Cardionics™, and OtoSim™.

Our updated website provides you with a simple way to create a Purchase Order with the "ADD TO QUOTE" feature.

Visit us @ medicalshipment.com

I would like to thank all of my employees for their hard work and dedication to making this company what it is today.



Daniel Micic
CEO, Founder/President

Table of Contents

Foley Catheter Tray 12Fr or 14Fr • Tracheostomy Care Kit • Dressing Change Tray • Irrigation Tray with Piston Syringe or Bulb Syringe • Simulated Swabsticks (Wet) • Simulated Swabsticks (Dry)	4–7	Medical Shipment Products
Emergency • Medication • Isolation • Pediatric • Media • Storage • Utility • Shelving • PPE • Manikin • Supply • Hamper • Polymer • Wire • Metro Carts	8–15	Carts
Customized • Defibrillators • AEDs • Trainers • Simulators • ECGs • Carts/Stands	16–23	Defibrillators ECGs
BP • Doppler • Integrated Diagnostics • Oscopes • Ophthalmoscopes • Penlights • Scales • Stethoscopes • Thermometers • Diagnostic Tools • Glo Products • Centrifuges • Incubators • Counters • Microscopes	24–49	Diagnostics
Latex • Vinyl • Nitrile • Sterile • Surgical	50–53	Gloves
Bed Packages • Med/Surg • Multiposition • ICU • Birthing • Stretchers • Infant Warmers • Accessories	54–61	Hospital Beds
Alaris • B Braun • Baxter • Hospira • Smiths • Infusion Sets • IV Solutions • IV Catheters • Blood Collection	62–77	Infusion
Admissions • Allergy • General Office • Infection • Nursing • Pharmacy	78–89	Labels
Infant • Birthing • Exam • Oto/OphthoSim • Injection/ IV • CVC • BP • Airway • CPR • Auscultation • Dialysis • Suture/ Wound • Edema • Ulcer • Burns • Ostomy • SimLeggings	90–111	Manikins Simulators
Health • Women/Men's Health • Pregnancy/Childcare • Tobacco • Alcohol • Drugs • Nutrition	112–125	Media
Vital Signs Monitors	126–127	Monitors
Accuvein-Vein Viewing • Amico Diagnostics • Cardionics-Sam II, Pat • Metro-Access Point Cart • MetroMax iQ • SimLeggings • BTUSA Simulation Trainers • OtoSim • OphthoSim	128–133	New Products
Tape • Swabs • Bandages • Gauze • Advanced Wound Care • Personal Protection • Sanitizers • Disinfectant • Personal Care • EMS • Foley • Central Line • Surgical • Feeding Pumps • SCD • Ambulatory	134–171	Patient Care
Exam Tables • Blood Draw Chairs • Stools • IV Poles • Screens • Sharps Containers • Dispensers • Linens	172–177	Patient Room
Pyxis Practice Meds Starter Kit • Tablet • Capsule Pack • Flavors • Prefilled Syringes • Vials • Insulin Packs • Ampules • Training Liquids • Misc • Variety Packs/Kits	178–197	Practice Meds
Premium Package • Medstation 4000 4-Drawer • Single-Column, Four-Door Auxiliary Unit • Console & Cabinet • Medstation 4000 2-Drawer • Medstation 4000 Workstation	198–201	PYXIS®
Masks • Accessories • Tracheostomy • Suction Catheters • Peakflow • Pulse Oximeter • Airways	202–207	Respiratory
Customized Nursing Kits • Nursing Supply Kit • Phlebotomy Kit • IV Therapy Kit • Student Protection Kit • Infection Control Kit • Accessories Kit • Insulin Injection Training Kit • Ostomy Kit	208–211	Student Kits
BD • Bak'Snap • Exel • Kendall • McKesson • Smiths • Terumo	212–219	Syringes
Mobile • Functional • Non Functional • Accessories	220–223	Training Headwall Units

Medical Shipment Products

Carts

Defibrillators
ECGs

Diagnostics

Gloves

Hospital
Beds

Infusion

Labels

Manikins
Simulators

Media

Monitors

New
Products

Patient
Care

Patient
Room

Practice
Meds

PYXIS®

Respiratory

Student
Kits

Syringes

Training
Headwall
Unit

..... Save More



PRE-CONNECTED CLOSED FOLEY SYSTEM

The 14Fr and 12Fr, 5mL Foley Catheter comes with a 2000mL Anti-Reflux Drainage Bag and a Needleless Sampling Port.

- (1) Foley urethral catheter
- (1) 2000mL Drainage bag with pre-connected foley with 5mL balloon
- (1) Syringe, 10mL, pre-filled with sterile water
- (2) Medium, latex-free powder-free, vinyl gloves
- (1) Moisture-proof underpad
- (1) Absorbent fenestrated drape
- (2) Packages simulated swabsticks with distilled water
- (1) Rubber band and bed sheet clamp
- (1) Lubricating jelly packet
- (1) Urine collection vial with cap and label
- (1) Tamper-evident seal
- (1) Prep deck

#8501cs	14Fr	10/case	\$89.99
#8502cs	12Fr	10/case	\$89.99

TRACHEOSTOMY CARE TRAY

- (1) 3-Compartment tray
- (1) Cleaning brush
- (4) 4" x 4" Non-woven sponges
- (1) Pipe cleaners
- (1) Pair vinyl gloves, cuffed
- (1) Cotton tip applicators
- (1) Twill tape
- (1) Tracheostomy dressing
- (1) Waterproof drape

#8503cs	20/case	\$49.99
---------	---------	----------------

Carts

Defibrillators
ECGs

Diagnostics

Gloves

Hospital
Beds

Infusion

Labels

Manikins
Simulators

Media

Monitors

New
Products

Patient
Care

Patient
Room

Practice
Meds

PYXIS®

Respiratory

Student
Kits

Syringes

Training
Headwall
Unit

Buy the Case!



DRESSING CHANGE TRAY

Teach dressing change techniques in the Simulation Lab. Our exclusive dressing change tray includes simulated swabsticks for use on manikins and simulators.

- (1) Tray
- (1) Polylined drape
- (1) Polybag with twist tie
- (4) 4" x 4" Gauze dressing
- Transfer forceps
- (1) 1" x 36" Plastic tape
- (1) 5" x 9" Abdominal pad
- (1) 2" Safety pin
- (1) Pouch of 3 simulated swabsticks

#8504cs 20/case **\$59.99**

IRRIGATION TRAY WITH PISTON SYRINGE

- (1) 60mL Piston syringe
- (1) 800mL Basin tray
- (1) Waterproof drape
- (1) Alcohol prep pad
- (1) 500mL Graduated container

#8505cs 20/case **\$29.99**

IRRIGATION TRAY WITH BULB SYRINGE

- (1) 60mL Bulb syringe
- (1) 800mL Basin tray
- (1) Waterproof drape
- (1) Alcohol prep pad
- (1) 500mL Graduated container

#8506cs 20/case **\$29.99**

SIMULATED SWABSTICKS

#8508cs (wet)	3 swabsticks/pouch 25 pouches/box 10 boxes/case	\$57.99
#8509cs (dry)	10 swabsticks/bag 10 bags/case	\$18.99

**Clean, Easy,
Simple**

Medical Shipment Products Kits

Carts

Defibrillators
ECGs

Diagnostics

Gloves

Hospital
Beds

Infusion

Labels

Manikins
Simulators

Media

Monitors

New
Products

Patient
Care

Patient
Room

Practice
Meds

PYXIS®

Respiratory

Student
Kits

Syringes

Training
Headwall
Unit

PRE-CONNECTED CLOSED FOLEY SYSTEM

The 14Fr and 12Fr, 5mL Foley Catheter comes with a 2000mL Anti-Reflux Drainage Bag and a Needleless Sampling Port.

- (1) Foley urethral catheter
- (1) 2000mL Drainage bag with pre-connected foley with 5mL balloon
- (1) Syringe, 10mL, pre-filled with sterile water
- (2) Medium, latex-free powder-free, vinyl gloves
- (1) Moisture-proof underpad
- (1) Absorbent fenestrated drape
- (2) Packages simulated swabsticks with distilled water
- (1) Rubber band and bed sheet clamp
- (1) Lubricating jelly packet
- (1) Urine collection vial with cap and label
- (1) Tamper-evident seal
- (1) Prep deck



#8501	Pre-Connected Closed Foley System	14Fr	1/each	\$9.99
#8502	Pre-Connected Closed Foley System	12Fr	1/each	\$9.99

TRACHEOSTOMY CARE TRAY

- (1) Waterproof drape
- (1) 3-Compartment tray
- (1) Cleaning brush
- (4) 4" x 4" Non-woven sponges
- (1) Pipe cleaners
- (1) Pair vinyl gloves, cuffed
- (1) Cotton tip applicators
- (1) Twill tape
- (1) Tracheostomy dressing



#8503	Tracheostomy Care Tray		1/each	\$2.74
-------	------------------------	--	--------	---------------

SIMULATED SWABSTICKS

#8508bx (wet)	3 swabsticks/pouch 25 pouches/box	\$5.90
#8509 (dry)	10 swabsticks/bag	\$1.94



DRESSING CHANGE TRAY

Teach dressing change techniques in the Simulation Lab. Our exclusive dressing change tray includes simulated swabsticks for use on manikins and simulators.

- (1) Tray
- (1) Polylined drape
- (1) Polybag with twist tie
- (4) 4" x 4" Gauze dressing
- (1) 1" x 36" Plastic tape
- (1) 5" x 9" Abdominal pad
- (1) 2" Safety pin
- (1) Pouch of 3 simulated swabsticks
- Transfer forceps



#8504	Dressing Change Tray	1/each	\$3.09
-------	----------------------	--------	---------------

IRRIGATION TRAY WITH PISTON SYRINGE

- (1) 60mL Piston syringe
- (1) 800mL Basin tray
- (1) Waterproof drape
- (1) Alcohol prep pad
- (1) 500mL Graduated container



#8505	Irrigation Tray With Piston Syringe	1/each	\$1.54
-------	-------------------------------------	--------	---------------

IRRIGATION TRAY WITH BULB SYRINGE

- (1) 60mL Bulb syringe
- (1) 800mL Basin tray
- (1) Waterproof drape
- (1) Alcohol prep pad
- (1) 500mL Graduated container



#8506	Irrigation Tray With Bulb Syringe	1/each	\$1.54
-------	-----------------------------------	--------	---------------

Carts

EMERGENCY, MEDICATION

Carts are shipped via freight; call or email for pricing. 



SIX-DRAWER EMERGENCY (Deluxe Package)

- Four (4) 3" drawers, (1) 6" and (1) 12"
- Four (4) 3" and (2) 5" trays
- Defibrillator swivel shelf
- Suction unit holder
- Outlet strip
- Oxygen tank bracket
- Tray with lid and dividers
- Accessories require assembly
- 46-1/4" H x 25" D x 32" W
- IV pole
- Cardiac board
- (12) Label holders
- (100) Plastic seals
- Utility hooks

#220202	Deluxe Emergency Cart	\$2,499.00
---------	-----------------------	-------------------

THREE-DRAWER HYPERTHERMIA (with 1.6 cubic feet Refrigerator/Freezer)

- One (1) 3" and (1) 6" drawer
- Navy blue and beige finish
- Hospital-grade plug, 10' cord
- Plastic top
- (10) Cold packs
- Temperature indicator
- Security sealing system
- Assembly required
- 43-1/4" H x 26" D x 34-1/2" W
- Shipping weight 160lbs

#220205	Hyperthermia Cart	\$2,699.00
---------	-------------------	-------------------



THREE-DRAWER STEEL MEDICATION (Traffic White)

- Two (2) 3", (1) 9" drawers and (1) pull-out cassette
- 3" Locking narcotic drawer and 20-bin removable cassette
- 46-1/2" H x 25" D x 32" W
- Shipping weight 235lbs

#220501	Medication Cart	\$1,999.00
---------	-----------------	-------------------



Need a Custom Product Developed?

Contact Us 1-855-MED-SHIP

Defibrillators
ECGs

Diagnostics

Gloves

Hospital
Beds

Infusion

Labels

Manikins
Simulators

Media

Monitors

New
Products

Patient
Care

Patient
Room

Practice
Meds

PYXIS®

Respiratory

Student
Kits

Syringes

Training
Headwall
Unit

Carts are shipped via freight; call or email for pricing. 

Carts

EMERGENCY, ISOLATION, PEDIATRIC



Defibrillators
ECGs

Diagnostics

Gloves

Hospital
Beds

Infusion

Labels

Manikins
Simulators

Media

Monitors

New
Products

Patient
Care

Patient
Room

Practice
Meds

PYXIS®

Respiratory

Student
Kits

Syringes

Training
Headwall
Unit

Shown without accessories

A.

B.

C.

D.

E.

A. SIX-DRAWER PUSH-BUTTON LOCK

- Three (3) 3" drawers, (2) 6" drawers and (1) 9" drawer
- 46-1/4" H x 25" D x 32" W
- Shipping weight 185lbs

#220303	Without Accessories	\$1,899.00
#220304	With Accessories	\$2,699.00

B. FOUR-DRAWER STANDARD (Beige)

- Steel construction and locking top drawer
- One (1) 3", (2) 6" and (1) 9" drawer
- Four (4) casters, one with brake
- 34-1/4" H x 18-1/2" D x 30" W
- Shipping weight 142lbs

#220302	Standard Cart	\$999.00
---------	---------------	-----------------

C. SIX-DRAWER EMERGENCY (with Breakaway Lock)

- Red emergency cart
- Four (4) 3", (1) 6" and (1) 12" drawer
- 46-1/4" H x 25" D x 32" W
- Shipping weight 185lbs

#220204	Six-Drawer Cart	\$1,499.00
---------	-----------------	-------------------

D. FOUR-DRAWER MEDICATION (with Key Lock)

- Mini-tower with key lock, railing and coat rack
- One (1) 3" and (3) 9" drawers
- 46-1/4" H x 25" D x 32" W
- Shipping weight 162lbs

#220301	Four-Drawer Cart	\$1,399.00
---------	------------------	-------------------

E. FOUR-DRAWER MEDICATION (with Key Lock)

- One (1) 3" and (3) 9" lockable drawers
- 46-1/4" H x 25" D x 32" W
- Shipping weight 162lbs

#220502	Four-Drawer Cart, White	\$1,389.00
---------	-------------------------	-------------------



F.

F. NINE-DRAWER ALUMINUM PEDIATRIC (with Individual Breakaway Lock)

- Single (1) lock bar
- Four (4) casters; (2) braking, (1) tracking, one swivel
- Nine (9) color-coded drawers, (8) 3" and (1) 6"
- Metal pulls
- Stabilizer system (to prevent tipping)
- Dual handles
- Anti-microbial powder paint inside
- Removable ABS top
- Five-year warranty
- 47-1/4" H x 25" D x 32" W
- Shipping weight 160lbs

#220401	Pediatric Cart	\$1,799.00
---------	----------------	-------------------

Carts

MOBILE MEDIA, MOBILE STORAGE

Carts are shipped via freight; call or email for pricing. 

Defibrillators
ECGs

Diagnostics

Gloves

Hospital
Beds

Infusion

Labels

Manikins
Simulators

Media

Monitors

New
Products

Patient
Care

Patient
Room

Practice
Meds

PYXIS®

Respiratory

Student
Kits

Syringes

Training
Headwall
Unit



A.



B.



C.

A. LAPTOP TABLE (with Locking Cabinet)

- Integral safety push handle is molded to top shelf
- 15', 3-Outlet surge suppressing electrical assembly
- Cable track cord-management system
- 4" Casters, two with locking brake

- Molded shelves and legs won't stain, scratch, dent or rust
- Retaining lip and sure-grip safety pads prevent equipment from sliding
- Lifetime warranty

#220102

Laptop Table

\$369.00

B. CHILDREN'S STORAGE

- Designed for ages 2–8 with colorful primary colors
- Durable child-safe plastic prevents dents, rust and scratches
- 2-3/4" Deep storage shelves
- Easy to clean

- Child-safe casters
- 1" x 24" x 26" Tall
- Limited lifetime warranty
- Some assembly is required

#220642

Children Storage Cart

\$99.00

C. NEW REVERSIBLE, GLASS WHITEBOARD (Mobile)

- For marking on top of unique documents
- Provides a portable writing surface for smart boards, projectors and flat panel displays
- Will not stain or ghost
- Steel frame with silver finish
- Lock and pivot system allows glass up to tilt 8° in each direction

- Tempered 5/16" (8 mm) thick glass
- (4) locking non-marring grip swivel casters
- Board size: 30" W x 40" H
- Assembled: 35" W x 24" D x 68" H
- Lifetime warranty

#980107

Whiteboard

\$249.00

Carts are shipped via freight; call or email for pricing. 

MOBILE STORAGE, UTILITY

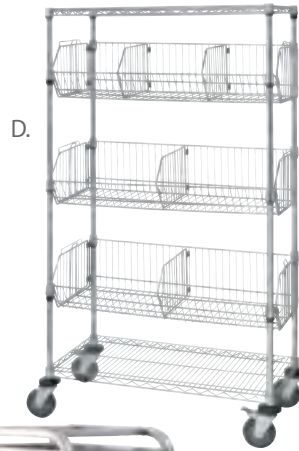

A. SEVEN-TUB RACK (Red)

- Seven (7) bins
- Rust-resistant wire frame, wire bottom shelf
- (4) Swivel casters
- 69" H x 24" D x 21" W

#220612	Seven-Tub Rack	\$499.00
---------	----------------	-----------------

B. SIX-TUB RACK (Gray)

- Solid, welded construction with (5) shelves
- (2) Locking casters and (6) dividers
- 69" H x 18" D x 36" W
- Weight 110lbs

#220613	Six-Tub Rack	\$499.00
---------	--------------	-----------------

C. THREE-TUB RACK (Gray)

- Same as item B (above), with (3) tubs
- 41" H x 27" D x 19" W

#220614	Three-Tub Rack	\$399.00
---------	----------------	-----------------

D. WIRE BASKET (Mobile)

- Solid, welded construction
- (5) Shelves, (2) locking casters and (6) dividers
- 69" H x 18" D x 36" W
- Weight 110lbs

#220617	Five-Shelf Mobile Cart	\$299.00
---------	------------------------	-----------------

E. FOUR-SHELF WIRE MOBILE (Shown without Casters)

- Durable wire cart
- (4) Casters, (2) with brakes
- 63" H x 18" D x 48" W
- 600–800lbs Capacity per shelf

#220616	Four-Shelf Mobile Cart	\$224.00
---------	------------------------	-----------------

F. TWO- AND THREE-SHELF WIRE UTILITY

- Features (2) "U" handles and (4) swivel casters, (2) locking
- 38" H x 18" D x 36" W

#220609	Two-Shelf Cart	\$166.99
#220610	Three-Shelf Cart	\$199.00

G. UTILITY (Assembly required)

- Integrated handle and 5" casters (2) swivel, (2) rigid, (2) shelves
- Medium 34-1/4" H x 17-1/2" D x 32-1/2" W
- Large 40" H x 26" D x 32-1/2" W

#220607	Medium	1/each	\$149.00
#220608	Large	1/each	\$199.00



Carts

Defibrillators
ECGs

Diagnostics

Gloves

Hospital
Beds

Infusion

Labels

Manikins
Simulators

Media

Monitors

New
Products

Patient
Care

Patient
Room

Practice
Meds

PYXIS®

Respiratory

Student
Kits

Syringes

Training
Headwall
Unit

Carts

Carts are shipped via freight; call or email for pricing. 

WIRED SHELVING, UTILITY, PPE DISPENSING



A. 4-SHELF CONSUMER GRADE WIRE SHELVING UNIT

- 300lb load capacity per shelf
- Snap together design assembles in minutes
- Shelves easily adjust on 1" centers to your exact needs
- Includes posts, shelves, and all hardware
- No tools required

#220622	18" L x 30" D x 72" H	\$169.00
#220623	18" L x 36" D x 72" H	\$179.00
#220624	18" L x 42" D x 72" H	\$189.00
#220625	18" L x 48" D x 72" H	\$199.00
#220626	24" L x 30" D x 72" H	\$209.00
#220627	24" L x 36" D x 72" H	\$219.00
#220628	24" L x 42" D x 72" H	\$229.00
#220629	24" L x 48" D x 72" H	\$239.00

B. 3-SHELF STAINLESS STEEL UTILITY

- Light duty transport and storage
- Unitized electronically welded stainless steel angle leg
- Bumpers on legs & handles
- Sound deadening panels under shelves
- Easily cleans and sanitizes
- 16-1/4" W x 27-1/2" L x 32-1/8" H

#220641	1/each	\$249.00
---------	--------	-----------------

C. CONTEMPORARY PLASTIC UTILITY

- High density polyethylene shelves
- Resists stains and odors
- Non-marking casters, push handles
- Shelves measure 28-1/2" L x 16" W
- Holds up to 300lbs

#220640	1/each	\$299.00
---------	--------	-----------------

PPE DISPENSING UNIT

- 1.2L container of hand sanitizer
- 30 Universal-size CONTROL* cover gowns
- Two (2) 50-count boxes of procedure masks
- Two (2) 25-count boxes of FLUIDSHIELD* visor masks
- Any combination of (3) boxes of 150-count STERLING* Nitrile exam gloves
- Wall-mountable or easily attached to a wheeled storage module



#220630	1/each	\$1,499.00
---------	--------	-------------------

Need a Custom Product?
Contact Us 1-855-MED-SHIP

Defibrillators
ECGs

Diagnostics

Gloves

Hospital
Beds

Infusion

Labels

Manikins
Simulators

Media

Monitors

New
Products

Patient
Care

Patient
Room

Practice
Meds

PYXIS®

Respiratory

Student
Kits

Syringes

Training
Headwall
Unit

Carts are shipped via freight; call or email for pricing. 

SUPPLY, MANIKIN, HAMPER



A. Comes with bins and cover



B.

Most Popular!



C.



Available with blue or white cover

A. FIVE-SHELF ADJUSTABLE CHROME SUPPLY

- Includes (2) small and (2) large sliding drawers
- (4) Casters for easy movement, (2) locking
- (8) Yellow bins (3) small, (3) medium, and (2) large
- (8) Blue bins, (4) small and (4) large, Blue velcro® cover
- 74" H x 18" D x 36" W

#220606	Five-Shelf Supply Cart	\$1,899.00
---------	------------------------	-------------------

B. SLANTED WIRE SHELVING UNIT WITH BINS (Mobile)

- (2) Horizontal and (5) slanted shelves; (2) locking casters
- (30) Tough durable bins
- Built-in rear hanglock allows bins to tilt out
- 74" H x 18" D x 48" W

#220615	Mobile Slanted Shelving Unit	\$489.00
---------	------------------------------	-----------------

SECURE CARE HAMPER

- Offers foot activated ABS heavy duty lid
- Double-ring bag holder provides quick bag insertion and bag lock
- (2) Locking casters for security
- Chrome finish
- Bag sold separately



#220611	Hamper	\$169.00
#220621	Hamper Bag	\$35.99

C. FIVE-SHELF MANIKIN STORAGE

- Holds 600-800lbs per shelf
- Features casters with brakes
- 80" H x 24" D x 72" W

#220601	Five-Shelf Storage Cart	\$799.00
#220602	Cart with Blue Cover	\$974.00
#220603	Cart with White Cover	\$974.00
#220604	Blue Cover Only	\$175.00
#220605	White Cover Only	\$175.00

Cover shipped separately.

HUGE SELECTION OF CARTS AND ACCESSORIES!

CARTS

- Anesthesia
- Emergency
- Hyperthermia
- Isolation
- Linen
- Medication

- Multi-Purpose
- Pediatric
- Powered Platform Carts
- Surgical
- Wired

ACCESSORIES

Questions Call 1-847-253-3000

Carts

Defibrillators
ECGs

Diagnostics

Gloves

Hospital
Beds

Infusion

Labels

Manikins
Simulators

Media

Monitors

New
Products

Patient
Care

Patient
Room

Practice
Meds

PYXIS®

Respiratory

Student
Kits

Syringes

Training
Headwall
Unit

Carts

Carts are shipped via freight;  call or email for pricing.

Defibrillators

EKGs

Diagnostics

Gloves

Hospital
Beds

Infusion

Labels

Manikins
Simulators

Media

Monitors

New
Products

Patient
Care

Patient
Room

Practice
Meds

PYXIS®

Respiratory

Student
Kits

Syringes

Training
Headwall
Unit



ACCESS POINT, POINT OF CARE COMPUTER/MEDICATION CART

- Battery-only replacement
- Fully-adjustable display mount
- Electronic lift
- Standard keypad controller
- Compact footprint

#220112	2 Tier	1/each	\$7,750.00
#220111	3 Tier	1/each	\$7,950.00
#220110	4 Tier	1/each	\$8,150.00

Carts are shipped via freight; call or email for pricing. 



LIFELINE CRASH CART

- Code cart
- Infection Control: Includes corrosion proof polymer materials, smooth rounded corners to allow for easy cleaning and Microban Antimicrobial Product Protection

#220402	1/each	\$2,139.00
---------	--------	-------------------



EMERGENCY CRASH

- Features 3", 6" and 9" LEC drawers; backboard with front assembly kit; IV pole with cart mount
- Adjustable defibrillator tray and side bin with locking system
- 38-3/4" H x 22-5/8" W x 38" D
- Weight 105lbs

#220201	1/each	\$2,419.00
---------	--------	-------------------



METROMAX i™ POLYMER SHELVING WITH MICROBAN ANTIMICROBIAL PROTECTION

- Corrosion-proof
- Easy to clean
- Built-in Microban antimicrobial protection
- Lifetime warranty against rust and corrosion

#220643	1/each	\$1,999.00
---------	--------	-------------------



Putting Nurses at the Heart of the Solution 

- Carts
- Defibrillators ECGs
- Diagnostics
- Gloves
- Hospital Beds
- Infusion
- Labels
- Manikins Simulators
- Media
- Monitors
- New Products
- Patient Care
- Patient Room
- Practice Meds
- PYXIS®
- Respiratory
- Student Kits
- Syringes
- Training Headwall Unit

Defibrillation

FULLY CUSTOMIZED DEFIBRILLATORS



FULLY CUSTOMIZABLE
Pick Your BRAND, OPTIONS, ACCESSORIES

1. BRAND	2. OPTIONS	3. ACCESSORIES
Zoll	New or Refurbished	Carrying Case
Phillips	AED NIBP CO ₂	Hard Paddle
PhysioControl/LifePak	Pacing Bluetooth EtCO ₂	Quick Combo Cable & Pads
	SPO ₂ Lock Out WiFi	Battery Load Tester/Discharger
	Extended Battery CCT Unit	AC Power Supply

RECONDITIONED

ZOLL M SERIES *(Reconditioned)*

- Optimal viewing
- Rectilinear Biphasic™ waveform & patented external pacing
- Unique PDA-based data management system
- Event documentation via internal memory
- Easy data transfer and archiving

#240121	Defibrillator	\$2,750.00
#240114	Hard Paddle	\$512.00



LIFEPAK 12 PORTABLE DEFIBRILLATOR *(Reconditioned)*

(Biphasic, 3-Lead, with Pacing)

- Large LCD display
- ADAPTIV™ Biphasic technology
- Multi-parameter monitoring
- Superb color graphics
- AC operated/internal back-up battery

#240115	Defibrillator	\$3,299.00
#240117	Standard Hard Paddle	\$520.00
#240116	12 Adapter, AC Power Adapter <i>(Refurbished)</i>	\$499.00



LIFEPAK 20 PORTABLE DEFIBRILLATOR *(Reconditioned)*

(Biphasic, 3-Lead, with Pacing)

- Large LCD display
- ADAPTIV™ biphasic technology
- Multi-parameter monitoring
- Superb color graphics
- Battery-operated/optional AC power cord

#240118	Defibrillator	\$4,299.00
#240119	Standard Detachable Hard Paddles	\$620.00



PHILIPS HEARTSTART *(Reconditioned with Pacing)*

- Ready-for-use visual indicator
- Stem1 clinical decision support tools
- Easy-to-use interface
- Large color display with normal or high-contrast view
- CPR guide with Q-CPR™ measurement & feedback tool

#240120	Defibrillator	\$4,999.00
---------	---------------	-------------------



Defibrillation

AEDS



NEW ZOLL AED PLUS PACKAGE (Reconditioned)

Includes: Lithium battery set, soft carry case, ZOLL data review software, and real CPR feedback tool

- Audio & visual prompts
- Rectilinear biphasic waveform
- One-piece adult CPR-D padz
- Five year warranty

#240103 AED Plus™ Package **\$1,799.00**



NEW LIFELINE VIEW AED

- Designed for real world application
- No moving parts to delay rescue
- Highly visible Yellow color
- Award-winning ergonomic design

#240113 Defibrillator **\$1,750.00**



LIFELINE (Reconditioned)

- Voice prompts
- No moving parts to delay rescue
- Highly visible Yellow color
- Award-winning ergonomic design

#240106 AED Plus Package **\$1,250.00**



NEW  **HeartSine SAMARITAN AED PAD**

- Designed for use in public areas
- Pediatric-Pak available for children under 55 lbs.
- Samaritan PAD Training DVD
- Data cable
- Carry case
- Ten year factory warranty

#240122 AED PAD **\$1,250.00**

SIMULATORS

CS1201 SIMULATOR

- Use with any defibrillator to simulate cardioversion
- ECG waveforms – VF, VT-HI, VT-LO, T de P, AFIB, AFLTR, PSVT, S TACH/ anterior ST depression, NSR, ASYS, SINUS/AMI, SINUS/AMI/ PVC, SINUS/ antero-septal ST elevation, 2nd I /lateral ST elevation, S BRDY/inferior ST elevation, S BRDY/IMI, 1st/RBBB, 2ND II/LBBB/PVC, 2nd II/LBBB
- Uses (4) "AA" alkaline batteries
- Low battery indicator
- Battery life is approximately 15 hours

#190601	1/each	\$719.00
---------	--------	-----------------



CS301 SIMULATOR

- Use with any defibrillator to simulate cardioversion
- ECG waveforms – VF, VT fast, VT slow, VT poly, AFIB, AFLTR, SVT, S TACH, NSR, ASYS, SINUS PVC, S BRDY, J BRDY, 2nd I, 2ND II PVC, 2nd II, 3rd
- Connect directly to defibrillator and external pacer, 17 ECG rhythms
- Connectors–RA, LA, LL, RL and PADS connectors
PhysioControl, Philips, Zoll, Welch Allyn/R2, Marquette
- Uses (1) 9V alkaline battery
- Low battery indicator & battery saver feature
- Three year warranty covers material and workmanship

#190602	1/each	\$599.00
---------	--------	-----------------



AED SIMULATOR

- Connect directly to your automatic external defibrillator
- Connectors–RA, LA, LL, RL and PADS connectors
PhysioControl, Philips, Zoll, Welch Allyn/R2, Marquette
- ECG waveforms – VF, VT-HI, VT-LO, VF/artifact, Sinus/artifact, SVT, NSR, ASYS
- Uses (1) 9V alkaline battery
- Low battery indicator
- Battery life is approximately 25 hours

#190603	1/each	\$425.00
---------	--------	-----------------



Defibrillation ECGS



Most Popular!

Internal thermal and external printers.



Record 12 ECG traces on letter-sized paper.

WE CARRY A FULL LINE OF **ECG ACCESSORIES!**
@ medicalshipment.com



Choose auto, manual, rhythm or HRV analysis.

6-CHANNEL PORTABLE ECG

(Prints 6-Channel with Interpretation)

- Built-in rechargeable battery & AC/DC power supply
- Pacemaker detection meets ANSI/AAMI EC11
- Diagnostic software for adults and pediatrics
- External archiving; USB flash disk; card reader
- 5.7" TFT color LCD, 640 x 480 dpi

#240202	ECG 6-Channel	\$1,999.00
#240306	Carry Bag 13" W x 12.8" H x 7.9" D	\$125.00
#240302	Replacement Lithium Battery	\$185.00
#240305pk	ECG Paper Z-fold; 8.5" x 11"; 100 Sheets	\$5.99

12-CHANNEL ECG (with Interpretation)

- Built-in high resolution thermal printer
- 8.4" color touchscreen with one-touch operation
- Automatic measurement and interpretation
- Real time waveform freezing
- 120-second ECG waveform reviewable
- 200 ECGs in internal memory
- Built-in rechargeable Li-ion battery

#240203	ECH with Interpretation	\$3,625.00
#240308	With Carry Bag 14" W x 12-1/4" H x 5-1/3" D	\$79.00
#240309	Replacement Lithium Battery	\$295.00
#240307pk	ECG Paper Z-fold; 8-1/2" x 11"; 100 Sheets/pack	\$11.20

3-CHANNEL ECG WIDESCREEN (with Interpretation)

- Built-in high-resolution thermal printer
- 8.4" color touchscreen with one-touch operation
- Automatic measurement and interpretation
- Real time waveform freezing
- Records 12 ECG traces on letter-size paper
- 200 ECGs in internal memory
- Built-in rechargeable Li-ion battery

#240201	ECG 3-Channel, Widescreen	\$1,175.00
#240304	Carry Bag, 10-3/5" W x 8-1/2" H x 5" D	\$39.50
#240302	Replacement Lithium Battery	\$185.00
#240301	ECG Paper Roll; 2" x 20 yards	\$5.99

ECGS

Welch Allyn CP150 RESTING ELECTROCARDIOGRAPH (Non-Interpretive)

- 12-lead multi-channel ECG
- 7" Color preview
- Touchscreen

#240206	CP150 (Non-Interpretive)		\$3,399.00
#240311bx	Electrode	100/box	\$13.99
#240317pk	ECG Chart Paper	CP 100/200/150	\$39.99
#240314	Electrode Adaptor	CP 100/200/150	\$6.99



Welch Allyn CP150 RESTING ELECTROCARDIOGRAPH (Interpretive)

- Touchscreen
- 12-Lead multi-channel ECG
- 7" Color preview
- Three (3) lead ECG preview
- ECG interpretation software
- Store up to 100 test results
- Advanced filters for optimal ECG trace quality

#240207	CP150 (Interpretive)		\$3,999.00
#240311bx	Electrode	100/box	\$13.99
#240317	ECG Chart Paper	CP 100/200/150	\$39.99
#240314	Electrode Adaptor	CP 100/200/150	\$6.99



SIMULATION PC-BASED ECG

- Handheld 12-channel ECG with solution analysis functions: timed vectorcardiogram, VCG(3D), SAECG, QT interval dispersion, HRT, HFECG, Frequency Spectrum Cardiogram, and 30s-900s HRV.
- 12-Lead acquisition with real time ECG waveforms display on PC screen
- Auto/Manual measurement and interpretation; Word/PDF/jpg formats for easy report transfer

#240204	Simulation ECG		\$1,699.00
#240205	ECG with Stress Software & Exercise Blood Pressure Monitor		\$1,699.00
#240311bx	Electrodes	100/box	\$13.99
#240317	ECG Chart Paper	CP 100/200/150	\$39.99
#240314	Electrode Adaptor	CP 100/200/150	\$6.99



Compatible with
Windows XP,
Windows Vista
and Windows 7



(Computer not included)

Defibrillation TRAINERS



LIFE/FORM 15-LEAD ECG PLACEMENT TRAINER

- Includes adult torso, 15-lead electronics box, power adapter, set of (13) leads, (w50) electrodes, (2) "C" batteries, hard carry case, and instruction manual
- Connection sites for (4) limb leads
- Ability to attach right- or left-sided electrodes
- Three year warranty

#240212	1/each	\$3,225.00
---------	--------	-------------------



LIFE/FORM AED TRAINER WITH BRAD CPR MANIKIN

- Both audio and written prompts in English
- Cables for training pad
- Large LCD display for written prompts
- Low battery indication, uses a 9V battery

#240112	AED Trainer with Manikin	\$550.00
---------	--------------------------	-----------------



LIFE/FORM UNIVERSAL AED TRAINER

- Cables for training pads plug into the rear of unit
- Large LCD display & low battery indicator
- Provides both audio and written prompts in English
- Volume adjustment
- 7-1/2" x 5" x 1-3/4"

#240110	AED Trainer	\$380.00
---------	-------------	-----------------

STANDS

NON-TILT STAND/COMPATIBLE WITH ALL ECGS

- Adjustable height, a soft-push handle and shelf for cables
- Four (4) locking, anti-slide casters for secure positioning
- Works with all ECGs

#240310	Non-Tilt Stand	\$799.00
---------	----------------	-----------------



ECG not included

ROLL STAND (with Basket and Locking Casters)

- Static weight
- Stainless metal design
- Locking casters
- Works with all ECGs

#240303	Roll Stand	\$399.00
---------	------------	-----------------



WelchAllyn OFFICE CART FOR CP 150/PC ECGS

- Two (2) side baskets for additional storage
- Four (4) free-wheeling plastic wheels
- Office cart weight: 36.8 lbs
- Works with CP150 (#240206 & #240207)

#220653	1/each	\$599.00
---------	--------	-----------------

Cable arm and lower shelf not included. May be purchased separately



Shown with cable arm & lower shelf

Need a Custom Product?

Contact Us 1-855-MED-SHIP

Carts

Defibrillators
ECGs

Diagnostics

Gloves

Hospital
Beds

Infusion

Labels

Manikins
Simulators

Media

Monitors

New
Products

Patient
Care

Patient
Room

Practice
Meds

PYXIS®

Respiratory

Student
Kits

Syringes

Training
Headwall
Units

Diagnostics

ANEROID/HANDHELD



Most Popular!



Quality and affordability

ANEROID NYLON CUFF (Black)

- Black enamel 30mmHg manometer
- Nylon cuff features size guide marking system
- Chrome-plated brass air release valve

#230124	Infant	\$31.99
#230119	Child	\$31.99
#230120	Small Adult	\$31.99
#230121	Adult	\$31.99
#230122	Large Adult	\$32.99
#230123	Thigh	\$34.99

ANEROID LATEX-FREE SPHYGMOMANOMETER

- Easy-to-read 300mmHg with air release valve
- For the cost-conscious healthcare provider

#230126	Infant (<i>arm</i>)	\$13.99
#230127	Toddler (<i>arm</i>)	\$13.99
#230115	Child (<i>arm</i>)	\$16.99
#230116	Adult M (<i>arm</i>)	\$9.99
#230117	Adult/L (<i>arm</i>)	\$19.99
#230118	Adult/XL (<i>thigh</i>)	\$19.99



PROSPHYG™ 775 BP LATEX-FREE CUFF

- Black enamel 30mmHg manometer
- Navy Blue nylon cuff
- Includes case and instructions

#230225	Child	\$28.99
#230226	Small Adult	\$28.99
#230227	Adult	\$28.99
#230228	Large Adult	\$32.99
#230229	Thigh	\$34.99



COTTON LATEX-FREE

- Black enamel 300mmHg manometer
- Chrome-plated deflation valve
- Gray cotton cuff, artery label and gauge holder
- Adult cuff
- Cuff range 23–40
- Exceeds industry standards
- Includes leatherette case and instructions

#230224	1/each	\$24.99
---------	--------	----------------

ANEROID KITS

POCKET ANEROID/SPRAGUE KIT

- Complete aneroid, matching case, and color-matched Sprague stethoscope
- Black enamel 300mmHg manometer
- Adcuff™ calibrated nylon cuff with proprietary Size Guide™ marking system prevents mis-cuffing
- Chrome-plated deflation valve
- Includes extra large, color-matched, dual pocket carry case
- 9" x 5" x 2"



#230652 1/each **\$56.99**

Don't see what you want?
Call 855-MED-SHIP



IV FANNY PACK KIT

- Includes: 760 Series Aneroid, Adscope 641 Sprague, Medicut shears, Adlite penlight
- Heavy duty multi-pocket nylon fanny pack

#230231 1/each **\$59.99**



FIELD SET KIT

(with Matching Nylon Case)

- Chrome-plated pocket aneroid with luminescent dial
- Adcuff™ nylon cuff with size guide
- Color-coordinated matching professional stethoscope and case

#230130 1/each **\$55.99**



MANUAL BP KIT *(with Stethoscope)*

- White numerals for easy reading
- Self-adjusting D-ring
- Features: size guide marking system, auto-deflation valve, and attached nurse scope

#230223 1/each **\$26.99**

Diagnostics

BLOOD PRESSURE/DIGITAL



Accurate and reliable with hospital-grade Sure BP technology.

Welch Allyn CONNEX® PROBP™ 3400 DIGITAL BP DEVICE

- 15-Second BP readings
- USB-connectivity to select EMR/HIS systems
- Compatible with cuff sizes from small child to thigh
- Rapid-charge lithium ion battery

#230216	Handheld	\$699.00
#230217	Wall Mount	\$749.00
#230218	Mobile	\$899.00



ADC ADVANTAGE 6021N AUTOMATIC DIGITAL BP MONITOR

- *Smart Logic Technology* determines ideal inflation level
- Measures systolic, diastolic pressure and pulse
- Recalls last 99 readings with date and time stamp for two users

#230207	Adult	\$58.99
#230208	Large Adult	\$66.99



ADC ADVANTAGE 6015N DIGITAL LATEX-FREE WRIST BP MONITOR

- Portable, economical and easy-to-use
- Measures systolic, diastolic pressure and pulse
- *Smart Logic Technology* determines ideal inflation level
- Recalls last 99 readings for two users
- Auto off

#230214	1/each	\$42.99
---------	--------	----------------



ADC New MODULAR DIAGNOSTIC STATION

- Station includes up to 3 modules; blood pressure, temperature, pulse oximetry
- Configured at the factory or upgraded in the field at any time
- Two year limited warranty

#230219	Station	\$1,899.00
#230220	Mobile Cart	\$349.00
#230221	Desk Caddy	\$79.99
#230222	Wall Mount	\$79.99



ADC ADVANTAGE 601T DIGITAL LATEX-FREE WRIST BP MONITOR

- New 8 bit microprocessor for more accurate readings
- Measures systolic, diastolic pressure and pulse
- *Smart Logic Technology* determines ideal inflation level
- Recalls last 99 readings for two users

#230215	1/each	\$57.99
---------	--------	----------------



ADC ANEROID DIGITAL E-SPHYGMOMANOMETER

- Splash-resistant housing
- Swivel cuff clip
- Manometer works with virtually every cuff on the market
- Features auto off, dual low battery warnings, recalibration reminder
- Includes (2) "AAA" batteries & lifetime calibration warranty

#230109	Digital Aneroid	\$69.99
---------	-----------------	----------------

BLOOD PRESSURE/MOBILE

LARGE FACE MOBILE ANEROID

- Easy-to-read 6" luminescent dial for high visibility
- 300mmHg No-pin stop movement
- Includes the latex-free Adcuff nylon cuff, Adflow bulb and coiled tubing
- Includes all necessary hardware

#230110	Mobile	Adult	\$249.00
#230111	Wall Mounted	Adult	\$119.99
#230202	Cuff	Adult	\$10.99
#230252	Bladder	Adult	\$10.99
#230253	Cuff & Bladder		\$15.99
#230254	Bulb		\$5.99



#230111

Latex Free



E-SPHYG II DIGITAL SPHYGMOMANOMETER

- Dual display, dual mode
- Displays air pressure, deflation rate, systolic, diastolic pressure and pulse
- NICAD rechargeable battery
- AC adapter

#230112	Mobile Digital			\$559.00
#230201	Adult Cuff	Royal Blue	S (19-27cm)	\$9.99
#230203	Adult Cuff	Navy	M (23-40cm)	\$9.99
#230251	Adult Cuff	Burgundy	L (34-50cm)	\$15.99
#230255	Basket for E-Sphyg II			\$22.99



MOBILE ANEROID SPHYGMOMANOMETER

- Five-leg mobile stand
- Flexiport reusable 2-tube cuff
- Ten year warranty

#230101	Mobile Aneroid	\$499.00
#230234	Reusable Cuffs Infant	\$29.99
#230235	Reusable Cuffs Small Child	\$29.99
#230236	Reusable Cuffs Child	\$29.99
#230237	Reusable Cuffs Small Adult	\$29.99
#230238	Reusable Cuffs Adult	\$29.99
#230239	Reusable Cuffs Large Adult	\$34.99
#230240	Reusable Cuffs Thigh	\$53.99

Diagnostics

BLOOD PRESSURE/MOBILE, SIM BP



Amico MOBILE DIAGNOSTIC STATION

Mobile Stand, Ophthal & Oto, Dispenser, Aneroid & Cuff

Includes:

- Roll stand with large 5-leg base for increased stability
- Large basket for easy storage of accessories
- Cord wrap for proper management of power cord
- Swivelling lens allows instrument access
- (18) unique aperture and filter combinations

#231002	1/each	\$1,499.99
---------	--------	-------------------

**Putting Nurses at the Heart
of the Solution**



BPSim™

- Provides controlled practice to achieve high competency in detecting and measuring blood pressure
- Realistic manual blood pressure cuff can be used on standardized patients and mannequin simulators
- Works with any standard stethoscope

#230247	BPSim Blood Pressure Cuff	\$1,990.00
#230249	BPSim Control Pad	\$445.00
#230248	BPSim Cuff and Pad Bundle	\$2,490.00

DOPPLER

ULTRASONIC TABLETOP DOPPLER WITH WIRELESS

- Offers the application of infrared transmission technology
- Large digital display
- Includes 2MHz probe

#230314	Wireless Probe With Wireless	\$1,099.00
#230313	Tabletop Doppler without wireless	\$949.00
#230315	2MHz Probe (not wireless)	\$199.00
#230316	3MHz Probe (not wireless)	\$169.00



Shown with wireless probe

MINI DOPPLEX DOPPLER (Audio-Only)

- Can be used for vascular or fetal applications
- Choose 2, 3, 5 or 8MHz probe

#230301	Mini Dopplex Doppler	\$699.00
#230309	2MHz Probe Additional Probe	\$339.00
#230310	3MHz Probe Additional Probe	\$339.00
#230311	5MHz Probe Additional Probe	\$349.00
#230312	8MHz Probe Additional Probe	\$349.00



PRO FETAL DOPPLER

- Compact, lightweight, ergonomic design
- Large backlight LCD display
- Includes 3MHz probe

#230302	Pro Fetal Doppler	\$399.00
#230304	2MHz Probe	\$149.00
#230305	3MHz Fetal Probe	\$149.00
#230306	4MHz	\$149.00
#230307	8MHz Probe (Vascular)	\$149.00
#230308	Standard Carry Case	\$29.99



ULTRASOUND GEL

- Aqueous, will not stain clothing or damage transducers
- Fragrance free, hypoallergenic, bacteriostatic, non-irritating non-greasy, easy refill

#230317	Blue	8.5 oz	\$1.49
#230319	Clear	8.5 oz	\$1.49
#230318	Blue	1.3 gallon	\$16.50
#230320	Clear	1.3 gallon	\$16.50



Diagnostics

INTEGRATED DIAGNOSTIC SYSTEMS

GREEN SERIES 777 INTEGRATED WALL DIAGNOSTIC SYSTEMS

All include:

- Wall board
- Wall transformer
- Macroview otoscope
- Coaxial ophthalmoscope
- KleenSpec dispenser



WelchAllyn INTEGRATED WALL SYSTEMS

Includes all of the items on the top list plus :

- Wall aneroid sphygmomanometer
- SureTemp Plus 690 electronic thermometer

#230404	1/each	\$1,750.00
---------	--------	-------------------



WelchAllyn INTEGRATED WALL SYSTEMS

Includes all of the items on the top list plus :

- Wall aneroid sphygmomanometer

#231001	1/each	\$1,399.00
---------	--------	-------------------



WelchAllyn INTEGRATED WALL SYSTEMS

Includes:

- Wall board
- Wall transformer
- Coaxial ophthalmoscope
- Diagnostic MacroView otoscope
- Kleenspec® dispenser

#231037	1/each	\$1,299.00
---------	--------	-------------------

WALL TRANSFORMER SETS

WelchAllyn

Includes:

- KleenSpec disposable specula dispenser, 100-240 V, 50-60 Hz AC, IEC plug type-B
- Instrument heads not included



#231039	1/each	\$650.00
---------	--------	-----------------



WelchAllyn

Includes:

- PanOptic ophthalmoscope with Cobalt Blue filter and corneal viewing lens

#231040	1/each	\$1,399.00
---------	--------	-------------------

INTEGRATED DIAGNOSTIC SYSTEMS

MODULAR DIAGNOSTIC SYSTEMS

All include:

- Easy customization
- Antimicrobial treated
- Multiple mounting possibilities
- Compatible with a wide variety of instrument heads, bulbs and specula

MODULAR DIAGNOSTIC STATION

Includes:

- Otoscope/ophthalmoscope, Specula dispenser, Aneroid & cuff, Grey wall board

#231059	Modular System	1/each	\$999.00
---------	----------------	--------	-----------------



MODULAR DIAGNOSTIC SYSTEM

Includes:

- Ophthalmoscope, otoscope, Aneroid & Cuff, Specula dispenser, Infrared Thermometry
- Direct wall-mount

#231047	Modular System	1/each	\$750.00
---------	----------------	--------	-----------------



MODULAR DIAGNOSTIC SYSTEM ANEROID BASKET

Includes:

- Aneroid gauge, Basket, Adult 2-piece cuff, Latex-free 8' coil
- Direct wall-mount

#231020	Aneroid Basket	1/each	\$129.00
---------	----------------	--------	-----------------



ADSTATION™ 5610 MODULAR WALL SYSTEM

Includes:

- Adscope LED otoscope, LED coaxial ophthalmoscope

#231041	Adstation 5610	\$799.00
#231042	Xen with Spec/ Wall	\$899.00
#231043	Wall Otoscope	\$599.00



Diagnostics

OTOSCOPIES, OPHTHALMOSCOPIES



ADC **POCKET OTOSCOPE/OPHTHALMOSCOPE PREMIUM TWO-HANDLE SET**

Includes:

- Pocket otoscope/ophthalmoscope
- Contains (5) Welch Allyn 2.75mm and (5) 4.25mm disposable specula
- One year instrument warranty

#230423	Pocket Otoscope/ Ophthalmoscope Set	\$249.00
#230940	Battery Handle For Pocket Instruments	\$49.99
#230475	Ophthalmoscope Head Only	\$99.99
#230476	Otoscope Head Only	\$69.99
#230941pk	Disposable Specula, 2.75mm, 850/pkg	\$35.99



ADC **POCKET OTOSCOPE/OPHTHALMOSCOPE SINGLE HANDLE SET**

- Compact, single handle 2.5V pocket diagnostic set
- Contains (5) Welch Allyn 2.75mm and (5) 4.25mm disposable specula
- One year instrument warranty
- 7-1/4" x 4-1/2" x 1-1/2"

#230424	Pocket Otoscope/ Ophthalmoscope Set	\$199.00
#230940	Battery Handle For Pocket Instruments	\$49.99
#230475	Ophthalmoscope Head Only	\$99.99
#230943	Hard Case	\$14.99
#230941pk	Disposable Specula, 2.75mm, 850/pkg	\$35.99



ADC **COMPLETE 2.5V DIAGNOSTIC SET**

- Full featured 2.5 V set with (5) different instruments
- "C" cell powered
- Satin finish battery handle
- Complete in zippered case
- Batteries not included

#230422	1/each	\$239.00
---------	--------	-----------------



Welch Allyn **FULL DIAGNOSTIC SET**

Includes

- Standard ophthalmoscope
- Macroview otoscope
- Rechargeable 60-minute power handle(s)
- Soft storage case
- Nickel-cadmium battery
- IEC plug type-A
- One year warranty

#230435	1/each	\$750.00
#230441bg	4.25mm Specula 850/bag	\$39.99

OTOSCOPES, OPHTHALMOSCOPIES



ADC STANDARD OTOSCOPE

- Specula in sizes 2.5mm, 3.5mm and 4.5mm
- Veterinary model includes 4mm, 5mm & 7mm specula sizes
- Powered by (2) "C" cell batteries (not included)
- Includes zippered leatherette storage pouch
- One year quality performance guarantee

#230425	Otoscope	\$79.99
#230426	Specula Adapter	\$4.50
#230427	Replacement Specula 2.5mm	\$3.39
#230428	Replacement Specula 3.5mm	\$3.39
#230429	Replacement Specula 4.5mm	\$3.39



Welch Allyn POCKETSCOPE 2.5 V SOFT CASE

- Includes a PocketScope Ophthalmoscope and Otoscope along with a PocketScope AA alkaline battery handle
- Halogen illumination

#230431	1/each	\$575.00
---------	--------	-----------------



#230233pk



#230942pk



#230244pk



#230243pk



Welch Allyn UNIVERSAL CHARGER DESK SET

- (2) Rechargeable NiCad Handles, Coaxial Ophthalmoscope, and MacroView™ Otoscope
- Accepts all Welch Allyn 2.5 V, 3.5 V, and PocketScope™ (requires adapter)

#231033	Coaxial	\$999.00
#230434	Panoptic	\$1,450.00

DURACELL COPPERTOP BATTERIES

#230233pk	9V	12/pack	\$41.67
-----------	----	---------	----------------

DURACELL ALKALINE BATTERIES

#230242pk	AA	4/pack	\$1.94
#230243pk	AAA	4/pack	\$1.99
#230244pk	C	12/pack	\$13.50
#230245pk	D	12/pack	\$11.30
#230246bx	9V	12/box	\$18.99

Welch Allyn DIGITAL MACROVIEW OTOSCOPE

- Insufflation port for pneumatic otoscopy
- Requires computer running Windows XP Service Pack 2.0 or higher
- Works with all existing Welch Allyn 3.5V power sources (handles and wall transformer)

#230430	1/each	\$1,099.00
---------	--------	-------------------

Diagnostics

VISION TESTING



ISHIHARA TEST CHART

- Simple and accurate method for discovering congenital color blindness and red-green blindness, each in two forms, complete and incomplete
- Includes (4) special plates for tests to determine the kind and degree of defect in color vision
- Specially designed album-type books for ease of handling color plates

#230457	10 Plates	\$219.00
#230458	14 Plates	\$229.00
#230459	24 Plates	\$299.00



FLAT EYE PROTECTOR

- Black sateen finish
- Elastic headband

#230462	1/each	\$1.49
---------	--------	---------------



STANDARD EYE LATEX-FREE OCCLUDER

- Shaped to occlude either eye without pressure
- Constructed of black plastic

#230460	1/each	\$7.99
---------	--------	---------------



EYE PROTECTOR

- Black sateen exterior with lining
- Latex-free elastic headband
- Note: Latex-free band is less elastic, compared to a latex elastic band

#230461	1/each	\$4.99
---------	--------	---------------



SNELLEN EYE CHART

- Non-reflective, matte finish with green and red color bars
- 20' Distance, 22" x 11"

#230451	1/each	\$8.49
---------	--------	---------------



KINDERGARTEN EYE CHART

- Shows easy to distinguish objects
- 20' Distance
- 14" x 9"

#230453	1/each	\$15.99
---------	--------	----------------



POCKET EYE CHART

- Precise, clear, legible
- Provides 20/800 distance equivalent testing at 14"

#230456	1/each	\$2.99
---------	--------	---------------

PENLIGHTS



ADL ADLIGHT PLUS DISPOSABLE PENLIGHTS

- Available with or without pupil gauge (white barrel)
- Measures 5" long, 1/2" diameter
- Available in 8 colors

#230464	Black	\$1.99
#230465	Orange	\$1.99
#230466	Red	\$1.99
#230467	Royal	\$1.99
#230468	Teal	\$1.99
#230469	Purple	\$1.99
#230470	White	\$1.99
#230471	White with Pupil Gauge	\$1.99



ADL ADLIGHT DISPOSABLE PENLIGHTS

- Sealed concentric beam, disposable diagnostic penlight
- Activated by depressing pocket clip
- Measures 5" long, 1/2" diameter

#230463	1/each	\$2.99
#300115	With Pupil Gauge	\$2.99



#230959

ADL METALITE II PENLIGHTS

- Aluminum housing
- Pocket clip for convenience
- (2) "AAA" batteries included

#230956	Black	\$3.75
#230957	Red	\$3.75
#230958	Royal Blue	\$3.75
#230959	Silver	\$3.75



#230953

ADL METALITE PENLIGHTS

- Reusable with brushed aluminum housing activated by push button
- (2) "AAA" batteries included

#230952	Silver	\$3.99
#230953	Black	\$3.99
#230954	White	\$3.99
#230955	White with Pupil Gauge	\$3.99

Diagnostics

SCALES

Health o meter



DIGITAL SCALE LB/KG

- Eye-level stand-on scale with height rod
- EMR connectivity via USB
- Functions: lb/kg conversion, lb/kg lock out, Body Mass Index (BMI), Zero Out/Tare, Hold/Release, Auto Zero, Auto Off
- (6) AA batteries included
- Two year limited warranty

#230508 1/each **\$395.00**

DETECTO



DUAL READING PHYSICIAN SCALE

- Durable steel construction
- Heavy-duty solid, stable base
- Electrostatic powder paint finish

#230513	Standard	\$229.00
#230514	Portable	\$269.00



DETECTO BABY SCALE

- Power requirements are (1) 9V alkaline battery (not included) and (1) 3V CR2032 lithium backup battery (included) for memory
- Display options include date and time and storage of previous weight

#230522 Baby **\$279.00**



DETECTO WET DIAPER/LAP SPONGE SCALE

- Stainless steel construction
- Snap to clean, a major consideration in the nursery

#230521 1/each **\$459.00**



Health o meter PORTABLE BABY SCALE

- Capacity: 50 lbs, Graduation: 1/4 lb
- Easy-to-clean plastic tray
- One year limited warranty

#230506 1/each **\$155.00**

SCALES

DIGITAL MEDICAL SCALE

- Available with or without a digital or mechanical height rod
- Equipped with a MedVue indicator designed for optimum performance
- Displays height, weight and Body Mass Index simultaneously
- 500lb x 0.2lb/225kg x 0.1kg capacity

#230517 1/each **\$950.00**



DETECTO LARGE DIAL SCALE

- Low-profile design and non-skid vinyl mat
- White, baked-enamel finish and four personal colorful indicators to mark one person's or a whole family's weights
- Easy-to-read 7" (18cm) dial

#230518 1/each **\$99.00**



DETECTO SLIMPRO LOW PROFILE FLOOR SCALE

- Accommodates all sizes of patients
- 440lb/200kg capacity
- Features a built-in carrying handle for portability
- 5-second weight hold

#230519 1/each **\$139.00**



HANDHELD BODY FAT ANALYZER

- Track body fat in the convenience of your own home
- Two modes, athletic and normal, provide accurate results based on your exercise regiment
- Delivers results in approximately seven seconds
- Features a nine person memory profile for the whole family

#230520 1/each **\$49.99**

DETECTO MECHANICAL CHAIR SCALE

- Plastic-molded seat for patient comfort
- Lift-away arms and footrest
- Die-cast beam readable from both sides

#230512 1/each **\$599.00**



Diagnostics

STETHOSCOPES, PEDIATRIC



VISTASCOPE

- Chestpiece design with (8) interchangeable designer diaphragms
- Stainless steel binaurals
- Scope ID Tag included
- Lifetime warranty on all parts

#230619	1/each	\$59.99
---------	--------	----------------



ADIMAL SCOPE

- Molded resin animal face chestpiece in pediatric size
- Includes interchangeable (7) animal face snap-ons: Panda, Frog, Koala, Deer, Monkey, Tiger and Bear

#230620	1/each	\$39.99
---------	--------	----------------



PEDIATRIC ADSCOPE

- Stainless steel binaurals
- Available in 4 striking colors
- Lifetime warranty

#230602	Pediatric	\$34.99
#230603	Infant	\$34.99



STETHOSCOPES

- Non-chill anodized chestpiece
- 22" Latex-free PVC flexible tubing with adjustable binaural

#230625	Single	\$2.99
#230626	Dual Head	\$3.25



SPRAGUE NURSE KIT

- Includes single-tube Sprague scope, interchangeable chestpiece fittings, pocket/case, 5-1/2" Lister scissors, 3-color pen, and Adlite disposable diagnostic penlight

#230630	Sprague Nurse Kit	\$29.99
#230631	Nurse Combo-One	\$29.99
#230632	Nurse Combo-Lite	\$19.99



TEACHING SCOPE

- Features non-chill bell and diaphragm, (2) clinical headsets (1 Black, 1 Royal), with flexible 22" PVC tubing and stainless steel binaurals
- Includes spare diaphragm, extra Adsoft and standard eartips, and ID tag
- Lifetime warranty on all parts

#230624	1/each	\$69.99
---------	--------	----------------

STETHOSCOPES

ELECTRONIC STETHOSCOPE

- Amplifies up to 16x (24db) over traditional acoustic scopes
- Uses (1) "AAA" battery (included)
- Two year warranty

#230605	1/each	\$224.50
---------	--------	-----------------



DUAL HEAD SCOPE (Specify Color)

- Stainless steel binaurals
- Available in Burgundy, Black, Dark Green, Gray, Navy or Red
- Spare Adsoft Plus Eartips included
- Lifetime warranty

#230601	1/each	\$46.91
---------	--------	----------------



ULTRA-LITE ADSCOPE

- Affordably-priced stethoscope
- Lightweight aluminum
- Lightweight design
- Five year limited warranty

#230604	1/each	\$17.99
---------	--------	----------------



DISPOSABLE STETHOSCOPE

- Single-use scope
- ABS construction
- May be ETO sterilized and incinerated
- Individually packaged in sealed polybag

#230623	1/each	\$2.90
---------	--------	---------------



PREMIUM STETHOSCOPE ID TAG

- Polypropylene tag protects your investment
- Locks onto the tubing of most stethoscopes and blood pressure instruments
- Room for personalization

#230629	Premium	\$1.49
#230628	Standard	\$1.99



SCOPE HIP CLIP

- Easy-to-use, lightweight plastic waistband clip
- Reduces neck strain
- Available in Black, Blue, Purple, or White

#230627	1/each	\$3.99
---------	--------	---------------



ABC CONVERTIBLE CARDIOLOGY STETHOSCOPE (Dark Green)

- Provides enhanced acoustic response in adult and pediatric diaphragms
- Non-chill bell and diaphragm retaining rims for patient comfort
- Adsoft™ Plus silicon

#230644	1/each	\$99.00
---------	--------	----------------

Diagnostics

STETHOSCOPES



CLASSIC II S.E.

- Two-sided traditional combination chestpiece
- Tunable diaphragm on one side, traditional bell on the other
- Anatomically designed headset

#230636 1/each **\$98.99**



TEACHING SCOPE, CLASSIC II S.E.

- Dual headsets
- 40" Tube
- Traditional bell on one side, a diaphragm on the other
- Pressure-based sound frequency adjustment with tunable diaphragm

#230633 1/each **\$129.99**



MASTER CLASSIC II

- Ergonomic design
- Anatomically designed headset
- Pressure-based sound frequency adjustment with tunable diaphragm
- Patented 3M Littmann® Snap Tight Soft-Sealing Eartip

#230634 1/each **\$146.99**



ELECTRONIC STETHOSCOPE

- Record and save up to (12) 30-second patient sound tracks
- Transmit sounds via Bluetooth® technology (*Bluetooth® adaptor included. Not compatible with Apple devices*)

#230635 1/each **\$474.99**



Caribbean Blue Shown

SELECT

- 28" Tube
- Single-sided chestpiece
- Non-chill rim & diaphragm
- Other colors available

#230637 1/each **\$61.99**



CLASSIC III

- High acoustic sensitivity
- Single-piece tunable diaphragm is easy to attach and easier to clean
- Snap-tight eartips
- Five year warranty

#230651 1/each **\$99.99**

THERMOMETERS



Welch Allyn SURETEMP® PLUS STARTER KIT (Wall Mount)

- Includes: oral probe; rectal probe; 1000 probe covers
- Monitor mode measures 3–5 minute temps
- Auto eject used probe covers
- Displays Fahrenheit or Celsius

#230709	Suretemp Plus Starter Kit	\$399.00
#230704bx	Disposable Probe Covers 25/box	\$2.49
#230704cs	Disposable Probe Covers 1,000/case	\$57.99



Welch Allyn SURETEMP® PLUS ELECTRONIC (Handheld)

- Includes oral probe, oral probe well
- Quickly captures accurate readings on all patient types
- Last temperature recall button

#230701	Suretemp Plus	\$290.00
#230706	Wall Holder	\$39.99
#230707	Rectal Probe Only	\$85.00
#230708	Oral Probe Only	\$85.00

SAVE more with CASE PRICE!
throughout the catalog



KENDALL-COVIDIEN FIRST TEMP GENIUS 2 TYMPANIC THERMOMETER

- Records and analyzes up to 100 temperatures and selects the most accurate reading
- Programmable display shows an oral, rectal, auxiliary, core, or absolute temperature

#230717	Genius 2	\$324.99
#230718bx	Probe Covers 96/box	\$7.39



FEBRIS TOUCH-FREE INFRARED THERMOMETER

- Backlit display
- Switch easily between Fahrenheit and Celsius
- Track measurements over time with 10 stored readings
- Built-in distance sensor

#230730	1/each	\$79.50
---------	--------	----------------



THERMOSCAN® PRO 4000 STARTER KIT

- Includes ThermoScan® Pro4000 Ear Thermometer, security base station and 800 probe covers
- Preheated probe tip and sensor

#230729	Pro 4000 Starter Kit	\$359.00
#230703	With Rechargeable Battery	\$299.99
#230702	Thermoscan Pro Only	\$209.99
#230705bx	Probe Covers 200/bx	\$17.75
#230705cs	Probe Covers 800/cs	\$69.99

Diagnostics

THERMOMETERS



FILAC 3000 AD ORAL THERMOMETER

- Features icon-based interface with backlight LCD display
- Equipped with an electronic anti-theft system
- Runs on (4) "AA" batteries
- Includes an oral probe and push-button probe cover ejection

#230713	Oral	\$247.00
#230714	Rectal	\$247.00
#230716	Rectal Probe Only	\$53.99
#230715bx	Covers 500/box	\$16.09



ADC INFRARED and DIGITAL THERMOMETERS

- Easy-to-use tympanic thermometer
- Infrared ear thermometer uses probe
- Digital model features probe-free design with large illuminated display

#230727	Infrared Ear	\$39.99
#230728	Digital	\$39.99



ADC THERMOMETER KIT

- Includes (1) Adtemp 413 oral thermometer (*Blue*); (1) Adtemp 413 rectal thermometer (*Red*); (100) disposable thermometer sheaths and countertop dispenser tray with rubberized feet

#230711	Thermometer Kit	\$16.99
#230712bx	Sheaths 100/box	\$4.50



DIGITAL THERMOMETER

- Quickly records and displays oral, rectal or axillary temperature with flexible tip
- Beeper sounds when peak temperature is reached.
- Easy-to-read LCD display; 10 second response; dual Fahrenheit/Celsius scale

#230724	Thermometer	\$1.99
#230725bx	Sheaths 100/box	\$3.24



3M TEMPA-DOT™ (Disposable)

- Measures oral or auxiliary body temperature
- Sterile
- Single use
- Individually wrapped

#230723bx	100/box	\$13.24
-----------	---------	----------------



Geratherm™ NON-MERCURY GLASS (Oral)

- Green (*oral*) or red (*rectal*) cap on case
- Dual Fahrenheit/Celsius scale
- Oval shape won't roll off surfaces

#230719	Oral	\$5.24
#230720	Rectal	\$5.24
#230721	Clinical	\$5.79
#230722bx	Sheaths 100/box	\$4.70

TESTING SUPPLIES



GASTROCULT TESTS & INSTRUCTIONS

- For detecting gastric occult blood and determining gastric pH in one device
- This CLIA Waived test gives results in 30 seconds for pH, and 60 seconds for occult blood
- Includes a convenient pH comparison chart for the clinically relevant range
- On-slide Performance Monitor®

#230803bx 40/box **\$104.99**



MULTISTIX 10 SG

- Gain a broader clinical insight into a patient's health
- Reliable testing for UTI, diabetes, and kidney disorders
- (10) Tests for important markers on a single strip
- Combined leukocyte/nitrite results for better prediction of UTI with fewer false negatives
- CLIA waived

#230801 100/bottle **\$59.99**



HEMOCULT SENA SINGLE SLIDE TEST CARDS

- Detects abnormal occult bleeding associated with gastrointestinal disorders
- Includes an enhancer for more readability
- Use results in significantly improved detection of adenomas and colo-rectal cancer
- CLIA waived

#230802bx 100/box **\$95.50**



QUICKVUE DIPSTICK STREP A

- Dipstick format allows for an easy-to-handle, off-line extraction process
- High sensitivity at low levels of colony count and 95% overall agreement to culture
- CLIA waived

#230812 50 Test **\$102.99**



QUICKVUE ONE-STEP COMBO HCG TEST

- Detects 25mIU/mL hCG in serum and urine
- Results in 5 minutes (serum)/ 3 minutes (urine)
- CLIA waived for urine

#230813 50 Test Kit **\$139.99**



QUICKVUE INFLUENZA

- Kit contains patient swabs, positive and negative controls, and is stored at room temperature
- CLIA-waived
- Takes less than 30 seconds hands-on time
- Color coded procedure card helps demonstrate each step of the test

#230814 50 Test Kit **\$399.00**

Diagnostics

DIAGNOSTIC TOOLS



TAYLOR PERCUSSION HAMMER

- Stainless steel handle
- 7-1/2" (19cm) Long

#230805	1/each	\$2.90
---------	--------	---------------



BUCK LATEX-FREE HAMMER

- Chrome-plated handle with 2-sided synthetic rubber head
- Handle conceals screw-in brush
- Needle contained within the head
- Overall length 7-1/2"

#230806	1/each	\$6.15
---------	--------	---------------



TUNING FORKS

- Non-magnetic, corrosion resistant aluminum alloy construction
- Extra long 2" handle of turned smooth aluminum

#230808	128hz with Weight	\$9.74
#230809*	256hz with Weight	\$9.64
#230810*	512hz	\$9.24
#230811*	1024hz	\$9.24

*Not shown

More Diagnostics Available

Contact Us 1-855-MED-SHIP



SKINFOLD CALIPER

- Durable, plastic construction
- Spring loaded arm assures reproducible pinch
- Includes instructions and charts

#230815	1/each	\$23.99
---------	--------	----------------



6' RETRACTABLE TAPE MEASURE

- Durable tape graduated with inches in black on one side and centimeters in red on reverse side
- Push-button, white plastic case

#230840	1/each	\$2.75
---------	--------	---------------



PRESSURE SORE/WOUND MEASURING DEVICE

- Use to measure the size of pressure ulcers, wounds or skin conditions of any kind
- Designed for single use, eliminates the risk of cross contamination
- Packaged in handy dispenser boxes

#230960	1/each	\$1.25
---------	--------	---------------

GLUCOSE TESTING

NEW!

Approved for Institutional Use



#230944

NEW!



#230945

NEW!



#230946

INFINITY AUTOMATIC CODING STARTER KIT

Includes:

- Meter
- (10) Strips
- (10) Lancets
- Solution
- Lancing device
- 5-Second result time
- Meter has computer download capability

NEW #230944	Infinity Starter Kit	\$9.99
NEW #230945	Test Strips 50/box	\$13.99
NEW #230946	Automatic Coding Control Solution	\$5.99



GLUCOCARD VITAL BLOOD GLUCOSE METER KIT

Includes:

- (1) Meter
- (10) Test strips
- Bottle of control solution
- Lancing device
- (10) Lancets
- Log book
- User manual & quick reference guide

#230938	Pink Meter Kit	\$21.49
#230823	Black Meter Kit	\$21.49
#230939	Blue Meter Kit	\$21.49
#230824bx	Test Strips 50/box	\$15.99



GLUCOCARD 01 GLUCOSE METER KIT

Includes:

- (1) Meter
- (1) Lancing device
- (10) Lancets
- (10) Strips
- (1) Control solution
- Log book
- User manual
- Carrying case
- (1) Battery
- CLIA waived

#230820	Glucose Meter Kit	\$17.95
#230821bx	Senior Test Strips 50/box	\$20.15
#230822	Control Solution	\$11.25

Diagnostics

LANCETS



BD SAFETY LANCETS (Blue)

- Blood volume: high flow
- 1.5mm x 2.0mm depth
- Lancet automatically retracts into the device

#230833bx	200/box	\$72.99
-----------	---------	----------------



ASSURE LANCE

- Blood volume: low flow
- Designed to help facilities meet OSHA requirements for needlestick safety
- 25g x 2mm 200/box
- 28g x 1mm 100/box

#230834bx	25g x 2mm	\$22.50
#230836bx	28g x 1mm	\$15.99



LANCET

- Blood volume: low flow
- Designed to help facilities meet OSHA requirements for needlestick safety
- 21g x 1.8mm 100/box
- 28g x 1mm 100/box

#230947bx	21g x 1.8mm	\$14.99
#230948bx	28g x 1mm	\$14.99
#230835bx	28g x 1mm 200/box	\$22.50



ADVANTAGE PRESSURE-ACTIVATED LATEX-FREE SAFETY LANCETS

- Needle automatically retracts
- No lancing device required
- Ready to use
- 28g x 1mm

#230950bx	100/box	\$8.99
-----------	---------	---------------



PRESSURE-ACTIVATED SAFETY LANCETS

- Needle automatically retracts
- No lancing device required
- 100/box

#230843bx	21g x 2.2mm	\$12.99
#230844bx	26g x 1.8mm	\$12.99
#230848bx	28g x 1.8mm	\$12.99



BUTTON-ACTIVATED SAFETY LANCETS

- Needle automatically retracts
- No lancing device required
- 100/box

#230845bx	21g x 2.4mm	\$12.99
#230846bx	26g x 1.8mm	\$12.99
#230847bx	28g x 1.8mm	\$12.99

GLO-PRODUCTS



GLO GEL

- Shows up brilliant Blue-White under UV light
- Used to demonstrate proper handwashing
- Each bottle can be used for 75–100 applications

#230825 1/each **\$18.90**



GLO POWDER

- 1.9 ounce bottle used to demonstrate proper surface cleaning
- Good for hundreds of demonstrations
- Brilliant White

#230832 1/each **\$12.90**



GLO BRUSH

- Apply a thin layer of powder to any surface quickly
- Refillable powder reservoir and a cover to protect bristles
- Includes a 4-ounce container of Glo Germ Powder

#230831 1/each **\$32.90**



GLO LIQUID

- Shows up brilliant Blue-White under UV light
- Used to demonstrate proper handwashing
- Each bottle can be used for 75–100 applications

#230816 1/each **\$18.90**



GLO LED UV FLASHLIGHT KIT

- Includes: hand-held LED ultra-violet flashlight, 8-ounce bottle of Glo Germ Gel, 1.9 ounce bottle of Glo Germ Powder, and battery case

#230826 9 LED Kit **\$66.90**
 #230827 21 LED Kit **\$73.99**



GLO UV LIGHT STICK

- 15-watt Electric lamp
- 20" Long

#230830 1/each **\$39.99**
 #230828 9 LED Flashlight **\$29.90**
 #230829 21 LED Flashlight **\$42.99**
 #181514 Training Mini-blacklight **\$10.99**

Diagnostics

CENTRIFUGES, INCUBATORS, COUNTERS



E8 FIXED SPEED CENTRIFUGE

- Higher speeds, quieter operation, lower chamber temperatures, shorter height, and auto-calibrating speed function
- 3,500 rpm fixed speed - for blood only
- 110/220V auto-switching power adapter (CE, UL, cUL approved)

#230841	Fixed Speed	\$349.00
#230842	Variable Speed	\$398.00



Best Seller!

8-PLACE UNIVERSAL CENTRIFUGE

- 8-place fixed-angle rotor
- LWS Universal centrifuge has a 110-220V auto-switching power adapter
- Ideal for blood, urine, and other fluids
- Variable speed, 800-3300rpm

#230849	1/each	\$599.00
---------	--------	-----------------



ZIPOCRIT 4-PLACE 75MM HEMATOCRIT

- Spins (4) 75mm capillary tubes at 10,000 rpms
- Designed for cell separations, microfiltration, and DNA preparations

#230852	1/each	\$325.00
---------	--------	-----------------



ANALOG INCUBATOR

- Perfect for pediatric, physician, and hospital labs
- Provide constant temperature accuracy (through the analog control and included thermometer) for nearly all lab applications: microbiology, egg incubation, cultures, and test kits

#230853	1/each	\$675.00
---------	--------	-----------------



DIGITAL INCUBATOR

- Better temperature stability/accuracy with the PID microprocessor
- Large LED temperature displays constant temperature (C and F) and even allows for locking in the temperature setting

#230854	1/each	\$1,099.00
---------	--------	-------------------



DIFFERENTIAL COUNTERS

- Manual counter designed for blood cell counting
- Acid-resistant, high-impact plastic body
- Bell alarm for 100th counted cell

#230850	5 Keys	\$175.00
#230851	8 Keys	\$195.00

MICROSCOPES



REVELATION III PLAN BINOCULAR

- Best-seller for physician and veterinarian clinics, and universities and medical schools
- Includes titanium-finished DIN achromatic or DIN Plan optics and a 30-year anti-fungal coating

#230856 1/each **\$850.00**



3 OBJECTIVE STUDENT PRO SCOPE (Monocular)

- Includes built-in mechanical stage, heavy cast alloy, all metal gearing, moveable 1.25 ABBE condenser, and clear DIN objectives
- Accessories include a dust cover, blue and green filters, z fuse, and spare bulb

#230857 1/each **\$335.00**



REVELATION III MICROSCOPE

- Comes with LED illumination, for daylight color, low heat, low power consumption, and super-long bulb life
- Quadruple forward-facing nosepiece, multiple ball bearing mounted, 30-year anti-fungal coating
- Range of traverse is 73mm x 43mm

#230859 1/each **\$645.00**



MINI VID 5.1 MEGA PIXEL WIFI CAM

(for IOS and Android for Tablets and Phones)

- Can be mounted to nearly any brand or type of microscope
- High resolution and fast frame rates
- Stream live images to multiple devices at the same time
- Built-in rechargeable batteries

#230871 1/each **\$819.00**



BIO VID HD VIDEO CAMERA

- True 1280 x 720 resolution, increased sensitivity, low-noise, and great color rendition
- Great for research, pathology, cytology, oncology, hematology
- Smooth LIVE image display-5 MP-SD Card-HDMI cable-C-mount

#230866 1/each **\$999.00**



#230961

#230935

MICROSCOPE ACCESSORIES

#230935bx	Clear Slides 72ct	\$5.50
#230951	Cover Glass 1oz	\$5.75
#230855	Immersion Oil	\$6.70
#230961pk	Pipet 500/pack	\$19.99

Don't see what you need?
Call 1-847-253-3000

Gloves

LATEX



SAFE-TOUCH™ LATEX POWDERED EXAM

- Ambidextrous
- Beaded cuff
- Low protein content
- 100/box; 1,000/case

#110109bx	Small	1-9 boxes	\$6.49
#110109cs		Case	\$61.00
#110110bx	Med	1-9 boxes	\$6.49
#110110cs		Case	\$61.00
#110111bx	Large	1-9 boxes	\$6.49
#110111cs		Case	\$61.00
#110112bx	XLarge	1-9 boxes	\$6.49
#110112cs		Case	\$61.00



SAFE-TOUCH™ LATEX POWDER-FREE TEXTURED EXAM

- Ambidextrous
- Beaded cuff
- Low protein content
- 100/box; 1,000/case

#110113bx	Small	1-9 boxes	\$7.20
#110113cs		Case	\$69.99
#110114bx	Med	1-9 boxes	\$7.20
#110114cs		Case	\$69.99
#110115bx	Large	1-9 boxes	\$7.20
#110115cs		Case	\$69.99
#110116bx	XLarge	1-9 boxes	\$7.20
#110116cs		Case	\$69.99



ACCUTOUCH® LATEX POWDER-FREE EXAM

- Non-chlorinated
- Micro-textured surface
- Polymer lined for easy donning
- 100/box; 1,000/case

#110101bx	Small	1-9 boxes	\$8.90
#110101cs		Case	\$86.00
#110102bx	Med	1-9 boxes	\$8.90
#110102cs		Case	\$86.00
#110103bx	Large	1-9 boxes	\$8.90
#110103cs		Case	\$86.00
#110105bx	XLarge	1-9 boxes	\$8.90
#110105cs		Case	\$86.00



ULTRA CARE® LATEX POWDER-FREE

- Easily dons over wet hands
- Polymer lined
- 100/box
- 1,000/case

#110117bx	Small	1-9 boxes	\$10.70
#110117cs		Case	\$99.00
#110118bx	Med	1-9 boxes	\$10.70
#110118cs		Case	\$99.00
#110119bx	Large	1-9 boxes	\$10.70
#110119cs		Case	\$99.00



LATEX LIGHTLY-POWDERED (Non-Sterile)

- For exams
- Smooth

#110123bx	XS	100/box	\$6.65
#110124bx	Small	100/box	\$6.65
#110125bx	Medium	100/box	\$6.65
#110126bx	Large	100/box	\$6.65
#110127bx	XLarge	100/box	\$6.65

SAVE more with CASE PRICE! 
throughout the catalog



NEW POWDER-FREE HIGH RISK

- Puncture Resistant
- 11"-12" long
- Polymer coated latex
- 10mm White/15mm Blue

#110128bx	10mL	Small	\$12.50
#110129bx	10mL	Medium	\$12.50
#110130bx	10mL	Large	\$12.50
#110131bx	10mL	XLarge	\$12.50
#110132bx	15mL	Small	\$12.50
#110133bx	15mL	Medium	\$12.50
#110134bx	15mL	Large	\$12.50
#110135bx	15mL	XLarge	\$12.50

VINYL, STERILE



POWDERED VINYL EXAM (Sterile)

- Pre-cuffed
- Ambidextrous
- Individual peel-open package
- 50 pairs/box
- 200 pairs/case

#110310bx	Small	1-9 boxes	\$29.95
#110310cs		Case	\$98.75
#110311bx	Med	1-9 boxes	\$29.95
#110311cs		Case	\$98.75
#110312bx	Large	1-9 boxes	\$29.95
#110312cs		Case	\$98.75



NEXT GENERATION LATEX-FREE POWDER-FREE VINYL STRETCH

- Comfortable, conforming fit
- Enhanced tactile sensitivity
- 100/box
- 1,000/case

#110501bx	Small	1-9 boxes	\$4.99
#110501cs		Case	\$47.00
#110502bx	Med	1-9 boxes	\$4.99
#110502cs		Case	\$47.00
#110503bx	Large	1-9 boxes	\$4.99
#110503cs		Case	\$47.00
#110504bx	XLarge	1-9 boxes	\$4.99
#110504cs		Case	\$47.00



SAFE-TOUCH™ LATEX-FREE POWDER-FREE VINYL

- Light to medium use
- FDA registered
- 100/box
- 1,000/case

#110509bx	Small	1-9 Boxes	\$5.25
#110509cs		Case	\$49.00
#110510bx	Med	1-9 Boxes	\$5.25
#110510cs		Case	\$49.00
#110511bx	Large	1-9 Boxes	\$5.25
#110511cs		Case	\$49.00
#110512bx	XLarge	1-9 Boxes	\$5.25
#110512cs		Case	\$49.00



SENSICARE® POWDER-FREE STRETCH VINYL EXAM (Sterile)

- Packaging resists tears
- 50 pairs/box; 200 pairs/case

#110313bx	Small	1-9 boxes	\$19.99
#110313cs		Case	\$75.00
#110314bx	Med	1-9 boxes	\$19.99
#110314cs		Case	\$75.00
#110315bx	Large	1-9 boxes	\$19.99
#110315cs		Case	\$75.00



LATEX-FREE LIGHTLY-POWDERED VINYL

- Contains no natural rubber latex
- Low cost choice for non-latex requirements.

#110513bx	Small	100/box	\$6.50
#110514bx	Medium	100/box	\$6.50
#110515bx	Large	100/box	\$6.50
#110516bx	XLarge	100/box	\$6.50

Supports the National
Breast Cancer Foundation



GENERATION LATEX-FREE GLOVES (Pink)

- Patented third-generation vinyl
- Barrier protection
- 100/box

#110521bx	XS	50/box	\$7.99
#110517bx	Small	50/box	\$7.99
#110518bx	Medium	50/box	\$7.99
#110519bx	Large	50/box	\$7.99
#110520bx	XLarge	50/box	\$7.99

Gloves

NITRILE



PULSE POWDER-FREE NITRILE EXAM

- Finger tipped textured
- Ultra-low modulus
- Chemo rated

#110222bx XS	200/box	\$13.99
#110223bx Small	200/box	\$13.99
#110224bx Medium	200/box	\$13.99
#110225bx Large	200/box	\$13.99
#110226bx XLarge	200/box	\$13.99



NITRIDERM™ EP LATEX-FREE POWDER-FREE NITRILE

- Textured finish
- Chemo drug tested
- 12" x 6mm

#110217bx Small	50/box	\$11.99
#110218bx Medium	50/box	\$11.99
#110219bx Large	50/box	\$11.99
#110220bx XLarge	50/box	\$11.99
#110221bx XXL	50/box	\$11.99



POWDER-FREE NITRILE EXAM (Black)

- Ambidextrous
- Extraordinary strength

#110201bx Small	100/box	\$7.99
#110202bx Medium	100/box	\$7.99
#110203bx Large	100/box	\$7.99
#110204bx XLarge	100/box	\$7.99



SAFE-TOUCH™ POWDER-FREE NITRILE EXAM

- No natural rubber proteins.
- Extraordinary strength
- Puncture resistance
- 100/box
- 1,000/case

#110205bx Small	1-9 boxes	\$6.75
#110205cs Case		\$64.00
#110206bx Med	1-9 boxes	\$6.75
#110206cs Case		\$64.00
#110207bx Large	1-9 boxes	\$6.75
#110207cs Case		\$64.00
#110208bx XLarge	1-9 boxes	\$6.75
#110208cs Case		\$64.00



TRUE ADVANTAGE™ POWDER-FREE NITRILE EXAM

- Chemo approved
- Polyglide lining
- Non-sulfur based curing process
- 100/box
- 1,000/case

#110209bx Small	1-9 boxes	\$7.95
#110209cs Case		\$76.00
#110210bx Med	1-9 boxes	\$7.95
#110210cs Case		\$76.00
#110211bx Large	1-9 boxes	\$7.95
#110211cs Case		\$76.00
#110212bx XLarge	1-9 boxes	\$7.95
#110212cs Case		\$76.00



LATEX-FREE POWDER-FREE NITRILE

- Textured finish
- Ultra low modulus

#110213bx Small	100/box	\$7.99
#110213cs Case	1000/case	\$77.50
#110214bx Medium	100/box	\$7.99
#110214cs Case	1000/case	\$77.50
#110215bx Large	100/box	\$7.99
#110215cs Case	1000/case	\$77.50
#110216bx XLarge	100/box	\$7.99
#110216cs Case	1000/case	\$77.50

NEW PRODUCTS

See pages 128–133

NITRILE, STERILE, SURGICAL



CAREMATES™ VYTRILE™ EXAM GLOVES (Sterile)

- Up to 3 times the strength of vinyl
- Individual peel-open package
- 100/box; 1,000/case

#110601bx	Small	1-9 Boxes	\$4.99
#110601cs		Case	\$46.00
#110602bx	Medium	1-9 Boxes	\$4.99
#110602cs		Case	\$46.00
#110603bx	Large	1-9 Boxes	\$4.99
#110603cs		Case	\$46.00
#110604bx	XLarge	1-9 Boxes	\$4.99
#110604cs		Case	\$46.00



LATEX POWDERED EXAM (Sterile)

- Superior strength
- Acute sensitivity
- Pre-cuffed and beaded

Singles

#110301	Small	Case 800	\$179.00
#110302	Medium		\$179.00
#110303	Large		\$179.00

Pairs

#110304	Small	Case 800	\$129.00
#110305	Medium		\$129.00
#110306	Large		\$129.00



NITRIDERM POWDER-FREE NITRILE CHEMO (Sterile)

- Ambidextrous
- Chemo rates
- 797 Compliant

#110317bx	Small		\$42.50
#110318bx	Medium	100 pairs	\$42.50
#110319bx	Large	/box	\$42.50
#110320bx	XLarge		\$42.50



NITRIDERM™ LATEX-FREE POWDER-FREE SURGICAL (Sterile)

- No natural rubber latex protein
- Individual peel-open package
- Maximum comfort
- Textured

#110408bx	6.0		\$34.99
#110409bx	6.5		\$34.99
#110410bx	7.0		\$34.99
#110411bx	7.5	25 pairs /box	\$34.99
#110412bx	8.0		\$34.99
#110413bx	8.5		\$34.99
#110414bx	9.0		\$34.99



POWDERED LATEX EXAM (Sterile)

- Low powder levels
- Individually wrapped

Singles

#110321bx	Small	100/box	\$24.75
#110322bx	Medium	100/box	\$24.75
#110323bx	Large	100/box	\$24.75
#110324bx	XLarge	100/box	\$24.75

Pairs

#110325bx	Small	50/box	\$17.25
#110326bx	Medium	50/box	\$17.25
#110327bx	Large	50/box	\$17.25
#110328bx	XLarge	50/box	\$17.25



LATEX POWDERED SURGICAL (Sterile)

- Textured surface
- One right, one left per paper wallet

Lightly Powdered

#110401bx	6.0		\$23.95
#110402bx	6.5		\$23.95
#110403bx	7.0	50 pairs/box	\$23.95
#110404bx	7.5		\$23.95
#110405bx	8.0		\$23.95
#110406bx	8.5		\$23.95
#110407bx	9.0		\$23.95

Powder Free

#110415bx	6.0		\$33.95
#110416bx	6.5		\$33.95
#110417bx	7.0	50 pairs/box	\$33.95
#110418bx	7.5		\$33.95
#110419bx	8.0		\$33.95
#110420bx	8.5		\$33.95
#110421bx	9.0		\$33.95

Hospital Beds

Hill-Rom BED PACKAGE

Beds are shipped via freight; call or email for pricing. 



Mattress Included

Wood tones may vary

Hill-Rom ADVANCE BED PACKAGE OVERBED TABLE & BEDSIDE CABINET (Reconditioned)

- Package includes: Advance bed, overhead table, and 3-drawer bedside cabinet
- Fully electric bed (Hi/Low, back section, knee section & Trendelenburg)
- Single button cardiac chair position
- Parallelogram side rails prevent entrapment and falls
- Side rails tuck away during patient transfer
- Bed can be equipped with exit alarm
- Complete controls located in foot board as well as both head end side rails
- Light sensor controlled night light
- All 4 wheels can be locked by one foot pedal
- 16" low height allows for easy patient care and egress
- Orthopedic sleep surface
- CPR release quickly flattens bed in the event of resuscitation
- Modern styling in a state of the art bed
- Bed with built in patient scale is OPTIONAL

#140328 1/each **\$2,495.00**

MEDICAL SHIPMENT'S RECONDITIONING PROCESS

- Bed **disassembled**, cleaned, sanded, and primed
- **Motors** disassembled and repacked with lithium grease
- Motor **couplings** and **capacitors** replaced as needed
- **Electrical** and **mechanical functions** and components are thoroughly checked
- Defective components **replaced**
- **Casters, brake** and **steering** functions completely disassembled, cleaned and adjusted
- **Side-rails** removed and locks repaired/replaced
- **New wheels** installed
- **Switches** replaced
- **Foot board** rebuilt with all new bumpers, decals, laminate
- **Circuit boards** checked, upgraded and replaced, if needed
- **Bed positions** tested under maximum load
- Bed **painted** with **hospital grade** two-part polyurethane coating
- All **metal parts** polished or plated if needed
- Bed **exit alarm** tested and calibrated, if included
- **Power cord** replaced with hospital-grade power supply
- **Safety check** of all wires and welds and grounding devices
- For **final inspection**, all components examined for proper operation and quality of workmanship
- **Electrical safety** and **leakage current tests** performed using AAMI test standards

Beds are shipped via freight; call or email for pricing. 

MED/SURG

Hill-Rom ADVANCE FULL ELECTRIC BED (Reconditioned)

- Hi/low and back/knee section
- Trendelenburg single button cardiac chair position
- Side rails tuck away during patient transfer
- Controls in footboard and head
- Side rails lock bed from any corner
- CPR release quickly flattens bed in the event of resuscitation
- 16" low height
- Optional patient scale
- One year warranty
- Includes mattress



Mattress Included

#140303 1/each **\$2,299.00**

Hill-Rom P1600 ADVANTA, ELECTRIC HOSPITAL BED (Reconditioned)

- 100-127 V, 60 Hz, 12 A, 42" W x 89" L, item powers up
- Cord included, overall length: 91"
- Retracted length: 78-1/2"
- Mattress support width: 35"
- Mattress support length: 83"
- Maximum width (siderails up): 42-3/4"
- Maximum width (siderails stored): 36"
- Maximum headboard height: 48"
- Maximum footboard height: 45"
- Includes mattress



Mattress Included

#140318 1/each **\$2,799.00**

stryker SECURE II 3002 (Reconditioned)

- 6" Casters
- Split zero-transfer-gap siderails (articulating)
- Dual pedestal design
- CPR release for backrest
- Knee gatch control
- Electronic function lockout control
- Four-wheel, steel-ring brake system with dual activation pedals
- Fowler angle gauge
- Locking steering caster
- Four traction sockets
- Removable headboard with CPR capability
- Retractable litter top
- (4) Foley bag hooks
- (6) IV sockets
- Patient restraint locations
- Full/reverse Trendelenburg
- Includes mattress



Mattress Included

#140319 1/each **\$2,999.00**

Carts

Defibrillators
ECGs

Diagnostics

Gloves

Hospital
Beds

Infusion

Labels

Manikins
Simulators

Media

Monitors

New
Products

Patient
Care

Patient
Room

Practice
Meds

PYXIS®

Respiratory

Student
Kits

Syringes

Training
Headwall
Units

Hospital Beds

MULTI-POSITION

Beds are shipped via freight; call or email for pricing. 



NEW ELECTRIC BED PACKAGE

- Includes mattress, bedside, cabinet, overbed tables, side rails†
- Full/reverse Trendelenburg positioning to 14°
- Multiple positioning; auto pause when returned to level
- Auto CPR; cardiac chair; edema foot ratchet
- Three year warranty

#140312	Bed Package With 3-Drawer Bedside Cabinet	\$2,750.00
#140313	Bed Package With One-Drawer, One-Door Bedside Cabinet*	\$2,750.00

*Not shown

†Mattress not shown



NEW FULL ELECTRIC BED WITH MATTRESS

- Includes mattress, bedside cabinet and overbed tablet
- Full rails, 3-drawer table
- Powerful DC motor; hi-lo motor pre-installed on foot section
- Welded motor-guard; meets HCPCS codes
- Positions: 9-1/2"–23-1/2"
- Lift: head 60°, knee 30° range
- Two year warranty

#140308	Full Rails; Three-Drawer Bedside Cabinet	\$1,625.00
#140309*	Half Rails; Three-Drawer Bedside Cabinet	\$1,625.00
#140310*	Full Rails; One-Drawer, One-Door Bedside Cabinet	\$1,599.00
#140311*	Half Rails; One-Drawer, One-Door Bedside Cabinet	\$1,599.00

*Not shown

†Mattress not shown



NEW FULL ELECTRIC BED WITH MATTRESS, WITH HALF RAILS

- Powerful DC motor
- Hi-Lo motor pre-installed on foot section
- Total assembled bed weighs only 178 lbs (bed and motor)
- All functions fully integrated into handheld pendant
- Includes mattress†

#140307	Half Rails	\$1,195.00
#140306	Full Rails	\$1,195.00

*Not shown

†Mattress not shown

Beds are shipped via freight; call or email for pricing. 

ICU

Hill-Rom P1900 TOTAL CARE BED (Reconditioned)

- Critical care bed with manual and electric side controls for all positions
- Trendelenburg positioning
- Removable head and foot boards
- Powered foot section; bed exit alarm
- Includes mattress

#140202	1/each	\$4,500.00
---------	--------	-------------------



Mattress Included

Hill-Rom TOTAL CARE SPORT (Reconditioned)

- Continuous lateral rotation therapy
- Percussion and vibration therapy, including postural setting options
- Weight based pressure redistribution in any bed position
- Advanced microclimate management technology
- Includes mattress

#140317	1/each	\$7,500.00
---------	--------	-------------------



Mattress Included

Do You Need Reconditioned Equipment?
Contact Us 1-855-MED-SHIP

stryker EPIC 2 (Reconditioned)

- Siderail and footboard positioning controls
- Chaperone bed exit system
- Optional zoom drive
- Radiolucent platform
- Integrated scale
- Backrest position
- Dual pedestal design
- Optional iBed awareness
- Includes mattress*

#140320	1/each	\$3,975.00
---------	--------	-------------------

*Mattress not shown



Mattress Included

Carts

Defibrillators
ECGs

Diagnostics

Gloves

Hospital
Beds

Infusion

Labels

Manikins
Simulators

Media

Monitors

New
Products

Patient
Care

Patient
Room

Practice
Meds

PYXIS®

Respiratory

Student
Kits

Syringes

Training
Headwall
Units

Hospital Beds

BIRTHING

Beds are shipped via freight; call or email for pricing. 



Mattress Included

Hill-Rom AFFINITY II BIRTHING BED (Reconditioned)

- Hinged seat and back sections keep mattress from bunching
- 43-1/2" high–22" low position for safe ambulating
- Foot section is removed in one step
- Fluid basin easily removed
- Foot supports adjust vertically and horizontally
- Central brake/steer; six casters increase mobility
- Includes mattress

#140101	1/each	\$2,999.00
---------	--------	-------------------



Mattress Included

Hill-Rom AFFINITY III BIRTHING BED (Reconditioned)

- Hinged seat and back sections
- Fluid basin easily removed
- Built-in foot supports adjust vertically and horizontally to position feet
- Easily removed headboard for patient access
- Manual Trendelenburg position from any height
- Tuckaway siderails for zero transfer gap with mattress
- Includes mattress

#140102	1/each	\$3,999.00
---------	--------	-------------------



Mattress Included

stryker® LD304 (Reconditioned)

- Convenient controls with single-button Trend-like positioning
- Patented Skoocher feature
- Simple operation
- Ergonomic design
- Includes mattress

#140321	1/each	\$3,299.00
---------	--------	-------------------

Beds are shipped via freight; call or email for pricing. 

STRETCHERS

Hill-Rom 8000 STRETCHER (Reconditioned)

- Ideal for the dynamic environment of the emergency room, PACU, operating room and ambulatory surgery facilities
- BackSaver Fowler feature
- 700 lb weight capacity
- 8" Caster size
- Includes mattress*

#140405	1/each	\$2,399.00
---------	--------	-------------------

*Not shown



Mattress Included

Hill-Rom GENERAL PROCEDURE STRETCHER (Reconditioned)

- Ideal for transport, recovery and minor procedures, with adjustable height controls located on both sides
- Back sections adjust
- Rails collapse and can be tucked away for zero transfer gap
- Brake all wheels from one pedal at any corner
- Hand-controlled Trendelenburg positioning
- 500 lb capacity
- Includes mattress

#140401	1/each	\$2,299.00
---------	--------	-------------------



Mattress Included

stryker 721 (Reconditioned)

- 21.5"; low (with long transfer board) 24.5"
- Litter positioning: backrest 0°-90°; Trend/reverse Trend ±12°
- Height range (to litter top): high 36"; low (with short transfer board)
- Overall length: 83" overall width: 30"
 - Assisted back rest
- Weight capacity: 500 lbs
 - Includes mattress*
- Fully hydraulic stretcher
 - One year warranty

#140403	1/each	\$2,199.00
---------	--------	-------------------

*xMattress not shown



Mattress Included

Carts

Defibrillators
ECGs

Diagnostics

Gloves

Hospital
Beds

Infusion

Labels

Manikins
Simulators

Media

Monitors

New
Products

Patient
Care

Patient
Room

Practice
Meds

PYXIS®

Respiratory

Student
Kits

Syringes

Training
Headwall
Units

Hospital Beds

INFANT WARMER

Beds are shipped via freight; call or email for pricing. 



OHMEDA 3300 INFANT WARMER (Reconditioned)

- Warmer with cart
- Three (3) drawers for storage
- Connections for air and suction

#140322	1/each	\$2,499.00
---------	--------	-------------------



Hill-Rom RESUSCITAIRE RADIANT WARMER (Reconditioned)

- Micro-processor controlled infant radiant warmer and resuscitator for use in the delivery suite or special care baby units
- Easy access bassinets
- Good temperature stability and uniformity
- Rapid warming in pre-warm mode
- Easy-to-use heater controls and prominent Apgar timer
- AutoBreath™ gas powered resuscitator

#140323	1/each	\$2,899.00
---------	--------	-------------------



AIRSHIELDS INFANT WARMER (Reconditioned)

- Dual function controller for skin servo/manual heat control
- Comprehensive alarm system, accurate skin temperature servo control, large digital skin temperature display, optimum procedures illumination
- Easy access for x-ray

#140324	1/each	\$2,299.00
---------	--------	-------------------

Need an Infant Warmer Not Shown Here?

Contact Us 1-855-MED-SHIP

Beds are shipped via freight; call or email for pricing. 

ACCESSORIES

BEDSIDE CABINET

- One-door and one-drawer
- 21" W x 18" D x 30" H
- Available in Light Oak, Medium Oak, Walnut

#140502	One Door and One Drawer	1/each	\$265.00
#140503	Three-Drawer Bedside Cabinet	1/each	\$325.00



BASIC OVERBED TABLE

- Infinite height adjustment between 28" & 44"
- Use with chair or bed

#140504		1/each	\$73.50
---------	--	--------	----------------

OVERBED WHITEBOARD TABLE

- U-base, (2) locking casters
- High-pressure healthgrade white board laminate for writing, drawing and communicating Industry's
- Infection resistant
- Seamless spill guard edge
- Integrated accessory rail for mounting baskets, kleenex containers, hand sanitizers, garbage or personal items
- Anodized aluminum column

#170135	Whiteboard Overbed Table		\$551.25
---------	--------------------------	--	-----------------



GOLD CARE LATEX-FREE FOAM MATTRESS

- Nylon top covers are bacteria resistant, flame retardant, fluid resistant, anti-fungal, anti-static, non-allergenic, have near 0% vapor transmission, and are easy to clean
- 35" x 80" x 16", 400 lb maximum weight capacity
- Five year limited warranty

#140325		1/each	\$219.00
---------	--	--------	-----------------



400 MATTRESS WITH RAISED BOLSTERS

- Firm bolster with 3" raised bolster
- 35" x 80"
- Four year warranty, 1 year on cover

#140326		1/each	\$299.00
---------	--	--------	-----------------



ADVANTAGE BARIATRIC MATTRESS

- For larger residents
- Anatomically designed for outstanding pressure redistribution and comfort
- 39" x 80"

#140327		1/each	\$450.00
---------	--	--------	-----------------

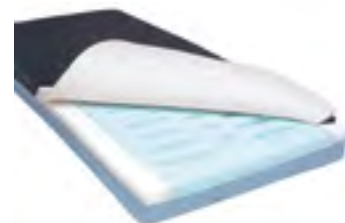

- Carts
- Defibrillators ECGs
- Diagnostics
- Gloves
- Hospital Beds**
- Infusion
- Labels
- Manikins Simulators
- Media
- Monitors
- New Products
- Patient Care
- Patient Room
- Practice Meds
- PYXIS®
- Respiratory
- Student Kits
- Syringes
- Training Headwall Units

Infusion

INFUSION PUMPS



CALL FOR SPECIAL PACKAGE PRICING
1-855-MED-SHIP



#130231

CareFusion 8000/8015 MEDLEYS
(Reconditioned)

#130209	PCU 8000	\$999.00
#130221	PCU 8015	\$1,299.00

CareFusion 8100 INFUSION MODULE
(Reconditioned)

#130210	Alaris 8100	\$1,199.00
#130311	Primary Set	\$7.99
#130312	Secondary Set	\$3.99

CareFusion PCU/INFUSION COMBO
(Reconditioned)

#130230	8000 & 8100	\$2,099.00
#130231	8015 & 8100	\$2,399.00
#130311	Primary Set	\$7.99
#130312	Secondary Set	\$3.99

INFUSION PUMPS



CareFusion PCU 8000 (Reconditioned)

- Adult, pediatric, and neonatal
- Customized infusion delivery
- Displays drug, dose and rate information
- Includes Educational Drug Library
- One year warranty

#130209	PCU 8000	\$999.00
---------	----------	-----------------



CareFusion PCU 8015 (Reconditioned)

- Color monitor
- Customized infusion delivery
- Displays drug, dose and rate information
- Includes Educational Drug Library
- One year warranty

#130221	PCU 8015	\$1,299.00
---------	----------	-------------------



CareFusion 8100 INFUSION MODULE (Reconditioned)

- Attaches to the Alaris 8000 Medley
- One year warranty

#130210	8100 Pump	\$1,199.00
#130311	Primary Set	\$7.99
#130312	Secondary Set	\$3.99

One Year Warranty Covers Parts & Labor On All Pumps



CareFusion 8110 SYRINGE MODULE (Reconditioned)

- Advanced pressure monitoring
- Attaches to the Alaris PCU 8000/8105
- One year warranty

#130212	Syringe Module	\$1,599.00
#130325	Extension Set 60"	\$6.99
#200947	Syringe, 60mL	\$0.99



CareFusion 8120 PCA MODULE (Reconditioned)

- Attaches to the Alaris PCU 8000/8105
- Auto pause and deactivation controls
- Syringe-based technology with secure drug access
- One year warranty

#130211	PCA Module	\$2,499.00
#130322	Extension Set 70"	\$23.99



CareFusion 8300 ETCO₂ MODULE (Reconditioned)

- Use for intubated and non-intubated mobility
- Use with oral or nasal breathing
- Reduce risks of opioid infusions
- Customizable profiles
- One year warranty

#130232	ETCO ₂ Module	\$1,999.00
# 121139	O ₂ Sampling Line	\$29.99

Infusion

INFUSION PUMPS

Baxter SIGMA SPECTRUM

(Reconditioned)

- Reduces the primary cause of adverse drug events
- Easy-to-read color display
- Use with standard IV administration sets
- One year warranty



#130217	Sigma Spectrum	\$2,999.00
#130307	Clearlink Primary Set	\$4.95
#130305	Clearlink Secondary Set	\$2.05

Baxter FLO-GARD® 6201

(Reconditioned)

- Single-channel all purpose
- Automatic piggybacking
- Air-in-line detection
- Automatic restart after an occlusion clears; hardware based and IV set free-flow protection
- One year warranty



#130214	Flo-Gard 6201	\$999.00
#130306	Primary Set	\$6.75
#130305	Secondary Set, 37"	\$2.05

Baxter FLO-GARD 6301

(Reconditioned)

- Uses standard IV administration sets
- Automatic piggybacking
- Air-in-line detection
- Automatic restart after an occlusion clears
- IV set free-flow protection
- One year warranty



#130215	Flo-Gard 6301	\$1,099.00
#130327	Solution Set	\$5.99
#130305	Clearlink Secondary Set	\$2.05

Hospira PLUM A+™ (Reconditioned)

- Fluid delivery for today's evolving healthcare environment
- Cassette-based, multi-function infusion system allows two lines in and one line out
- One year warranty



#130207	Plum A+	\$950.00
#130302	Primary PlumSet	\$7.29
#130326	Secondary PlumSet	\$2.35

Hospira A+ TRIPLE (Reconditioned)

- Concurrent delivery of 2 medications through a single patient line
- Air-in-Line detection and elimination, air trap captures up to 2mL of air
- Deliver secondary infusions via IV container or syringe
- One year warranty



#130233	A+ Triple	\$1,999.00
#130302	Primary PlumSet	\$7.29
#130326	Secondary PlumSet, 19"	\$2.35

Hospira LIFECARE PCA 3 (Reconditioned)

- Helps to enhance patient safety and efficiency through bar code technology and advanced software design
- Features easy-to-read key pad and clear design to help reduce the risk line mix-ups
- One year warranty



#130216	Lifecare PCA 3	\$999.00
#130303	PCA Minibore Set	\$8.99
#130304	PCA Extension Set	\$9.99
#130228	Lifecare PCA Injector	\$2.99

INFUSION PUMPS

CareFusion **IVAC SIGNATURE**

GOLD 7130 (Reconditioned)

- Single-channel infusion system with precision flow
- AccuSlide free-flow protection, advanced programming options, drug-specific dose rate calculator and IV
- One year warranty



#130213	IVAC 7130	\$899.00
#130328	Primary IV Set	\$5.99
#130329	Secondary Set	\$6.99

CareFusion **IVAC SIGNATURE**

GOLD 7230 (Reconditioned)

- Dual-channel device with independent programming on each channel
- Use for general IV infusions, antibiotics, blood infusions, enteral infusions, TPN, hyperalimentation
- One year warranty



#130219	IVAC 7230	\$950.00
#130328	Primary IV Set	\$5.99
#130329	Secondary Set	\$6.99

B BRAUN **OUTLOOK 100**

(Reconditioned)

- Real-time display of dose limit values during infusion for titration safety
- Active alphabetic matrix for quick and easy drug selection
- Enhanced battery life
- One year warranty



#130218	Outlook 100	\$1,099.00
#130330	Administration Set	\$7.99
#130331	Secondary Set	\$2.99

B BRAUN **HORIZON NXT** (Reconditioned)

- For use with B. Braun McGaw Horizon IV sets
- Capable of delivering fluid from a negative head height
- Provides clinically accepted volumetric accuracy for all standard IV fluids
- One year warranty



#130220	Horizon Nxt	\$799.00
#130330	Administration Set	\$7.99
#130331	Secondary Set	\$2.99

One Year Warranty Covers Parts & Labor On All Pumps

Hospira **GEMSTAR IV** (Reconditioned)

- Compact and portable
- Built on lightweight aluminum frames protected with color-coded bumpers
- One year warranty



#130222	Gemstar	\$1,699.00
#130332	Pumpset with 2 Filters, 96"	\$27.99

Hospira **PLUM XL** (Reconditioned)

- Dual-line volumetric infusion system
- Full compatibility with LifeCare PlumSets administration sets and accessories
- Convenient and cost-effective infusion system
- One year warranty



#130208	Plum XL Pump	\$599.00
#130302	Primary PlumSet	\$7.29
#130326	Secondary PlumSet, 19"	\$2.35

Infusion

SYRINGE PUMPS

MedFusion 3500 (Reconditioned)

- Features programmable upper and lower limits for dose, rate, bolus and loading doses
- Extensive delivery mode combinations; accepts 7 different syringe types
- One year warranty



#130402	Medfusion 3500	\$1,950.00
#200947	Syringe, 60mL	\$0.99

Baxter AS50 (Reconditioned)

- Can be piggybacked into an ongoing infusion line
- Infusion rates are programmable from 0.01 to 438 mL/hr
- One year warranty



#130401	Baxter AS50	\$999.00
#200947	Syringe, 60mL	\$0.99

Baxter AS40 (Reconditioned)

- Provides accurate, continuous and intermittent infusion through intravenous, intra-arterial, subcutaneous or epidural methods of infusion
- Accepts disposable standard syringes sizes from 1mL to 60mL
- One year warranty



#130403	Baxter AS40	\$999.00
#130314	Extension Set 36" Micro Volume	\$2.99
#200947	Syringe, 60mL	\$0.99

Baxter INFUS O.R. (Reconditioned)

- Modify dose without multiple reprogramming steps
- For administering drugs requiring multiple dosage adjustments
- SMART LABELS™ are magnetically coded/drug specific
- One year warranty



#130234	Baxter Infus O.R.	\$2,999.00
#200714	Monoject Syringe, 60cc	\$2.99

MedFusion 2010 (Reconditioned)

- Intravenous or arterial infusions of blood, lipids, fluids, antibiotic, meds and epidural infusions
- AC current or rechargeable internal batteries
- Has automatic sensing of syringe size
- 4-1/2" x 3" x 7-1/2"
- One year warranty



#130235	Medfusion 2010	\$899.00
#200947	Syringe, 60mL	\$0.99

MedFusion 2001 (Reconditioned)

- AC current or rechargeable internal batteries
- Can be programmed for continuous, auto or manual intermittent, or Volume/Time infusions
- Easy-to-read LCD screen
- LED alarm and function lights
- One year warranty



#130236	Medfusion 2001	\$850.00
#200947	Syringe, 60mL	\$0.99

PUMPS, NEW

NEW CADD LEGACY PCA

Includes:

- CADD Legacy PCA pump
- Single-use 550–100mL pump pouch
- (2) “AA” batteries
- Non-sterile demo cassette
- Operator’s manual
- Patient information guide
- Carrying case

#130237	CADD Legacy PCA	\$3,499.00
#130333	Extension Set	\$5.99

One Year Warranty Covers Parts & Labor On All Pumps

NEW!



NEW CADD LEGACY 1

Includes:

- CADD Legacy 1 pump
- Single-use 550–100mL pump pouch
- (2) “AA” batteries
- Non-sterile demo cassette
- Operator’s manual
- Patient information guide
- Carrying case

#130229	CADD Legacy 1	\$3,699.00
#130333	Extension Set	\$5.99

NEW!



NEW Medfusion 3500

- Ambulatory syringe pump that runs on either AC current or on rechargeable internal batteries
- User friendly with single-handed loading and a stackable horizontal design, mounting easily to an IV pole, an infant’s isolette or radiant warmer

#130405	Medfusion 3500	\$3,999.00
#130335	Extension Set	\$2.75

NEW!



Infusion

INFUSION SETS

 CareFusion **PRIMARY SET**

FOR 8100

- Check valve
- (2) Needle-free valves 79" and 6" from 2-piece male luer lock



#130311	1/each	\$7.99
#130311cs	20/case	\$155.00

 CareFusion **LATEX FREE PRIMARY SET FOR 7130/7230**

- AccuSlide® Flow Regulator
- Silicone pump segment



#130328	1/each	\$5.99
#130328cs	24/case	\$290.00



 CareFusion **SECONDARY SET FOR ALARIS PUMPS**

- Non-vented
- SmartSite needle-free valve, bag access port
- Fixed male luer lock and hanger
- Works with all Alaris pumps

#130312	1/each	\$3.99
#130312cs	100/case	\$375.00



 CareFusion **ADMINISTRATION SET FOR 8110**

- Microbore tubing, pressure sensing disc, fixed male luer lock
- Approximate set length: 60"
- Approximate priming volume: 0.8 mL

#130325	1/each	\$6.99
#130325cs	50/case	\$650.00



 CareFusion **ADMINISTRATION SET FOR 8120**

- Anti-siphon valve, microbore tubing segment, fixed male luer lock with reusable plunger
- Approximate set length: 62"
- Approximate priming volume: 1.6 mL

#130321	1/each	\$14.99
#130321cs	50/case	\$699.00



 CareFusion **EXTENSION SET 8120**

- Smallbore tubing segment
- Check valve
- (1) Needle-free valve 7" from 2-piece male luer lock

#130337	1/each	\$4.99
#130337cs	100/case	\$450.00

INFUSION SETS



B BRAUN ADMINISTRATION SET FOR OUTLOOK 100

- Universal spike
- Free flow protector clip
- Roller clamp
- Injection site 6" above distal end

#130330	1/each	\$7.99
#130330cs	24/case	\$185.00



B BRAUN SECONDARY SET FOR B BRAUN PUMPS

- 15 Drops/mL
- Universal spike
- Luer Lock, 40"

#130331	1/each	\$2.99
#130331cs	50/case	\$135.00



Baxter PRIMARY SET FOR FLO-GARD 6201/6203

- Male luer lock adapter with retractable collar
- Approximately 10 drops/mL
- Contains DEHP

#130306	1/each	\$6.75
#130306cs	50/case	\$299.00



Baxter SECONDARY SET FOR BAXTER PUMPS

- Use with CLEARLINK System
- Includes hanger for primary solution container
- Contains DEHP
- Fluid path is sterile, nonpyrogenic

#130305	1/each	\$2.05
#130305cs	48/case	\$93.50



B BRAUN PRIMARY PUMP SET FOR HORIZON NXT PUMP

- 15 Drops/mL
- Universal spike
- Pressure limited check valve
- SAFSITE injection sites 108", 68", and 6" above distal end
- Free-flow protector clip, roller clamp

#130334	1/each	\$9.99
#130334cs	24/case	\$225.00

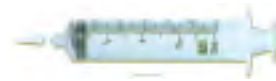

SYRINGE (Syringe Pumps)

#200715	Syringe, Luer Lok, 60mL	1/each	\$0.99
---------	-------------------------	--------	---------------



Baxter PRIMARY SET FOR SIGMA SPECTRUM

- Male luer lock adapter with retractable collar
- Approximately 10 drops/mL
- Contains DEHP

#130307	1/each	\$4.95
#130307cs	48/case	\$225.00

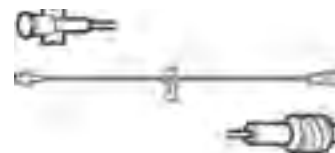

Baxter EXTENSION SET FOR BAXTER PUMPS (Sterile)

- Male luer lock adapter
- Non pyrogenic
- Approximate 36"

#130314	1/each	\$2.99
#130314cs	50/case	\$145.00

Infusion

INFUSION SETS



Hospira PRIMARY SET FOR PLUM A+

- Convertible piercing pin and sight chamber
- Slide clamp, cassette with capped secondary port
- Clave™ Y-site and Option-Lok™ male adaptor

#130302	1/each	\$7.29
#130302cs	50/case	\$345.00



Hospira PRIMARY SET FOR LIFECARE PCA 3

- PCA injector
- (2) Side clamps
- Female adaptor
- Option-Lok male adaptor
- Minibore Anti-Siphon

#130303	1/each	\$8.99
#130303cs	50/case	\$435.00



SIMPLIFY YOUR ORDERING PROCESS

medicalshipment.com



Hospira PRIMARY SET FOR GEMSTAR

- Pre-pierced Y-Site, 1.2 micron filter
- 96"
- Non-vented piercing pin
- Cassette
- Side clamp
- Secure lock male adapter

#130301	1/each	\$18.99
#130301cs	50/case	\$875.00



Hospira PUMPSET FOR GEMSTAR

- 1.2 micron filter
- 96"
- Pumpset
- (2) Filters

#130332	1/each	\$27.99
#130332cs	24/case	\$595.00

**Putting Nurses at the Heart
of the Solution**



IV SOLUTIONS[†]

WATER

#130125bx	Sterile Water for Injection	Vial	20mL	25/box	\$42.95
#130122bx	Bacteriostatic Water for Injection	Vial	30mL	25/box	\$39.99
#130128	Sterile Water Not for Injection	Cup	110mL	1/each	\$0.95
#130129	Sterile Water Solution	Cup	100mL	1/each	\$0.99
#130126*	Sterile Water for Injection		10mL	1/each	\$1.50
#130111	Baxter Sterile Water Pour Bottle		1000mL	1/each	\$4.75
#130111cs	Baxter Sterile Water Pour Bottle		1000mL	12/case	\$26.75



#130128



#130126

SODIUM CHLORIDE

#130130	Twist Top Saline	Cup	100mL	1/each	\$0.90
#130131	Foil Lid Saline	Cup	110mL	1/each	\$0.99
#130109	Baxter 0.9% NaCl		50mL	1/each	\$2.10
#130109cs	Baxter 0.9% NaCl		50mL	96/case	\$199.00
#130103*	Baxter 0.9% NaCl		100 mL	1/each	\$2.20
#130103cs	Baxter 0.9% NaCl		100 mL	96/case	\$209.00
#130105	Baxter 0.9% NaCl		250mL	1/each	\$3.30
#130105cs	Baxter 0.9% NaCl		250mL	36/case	\$115.00
#130107	Baxter 0.9% NaCl		500mL	1/each	\$3.40
#130107cs	Baxter 0.9% NaCl		500mL	24/case	\$79.00
#130101	Baxter 0.9% NaCl		1000mL	1/each	\$3.50
#130101cs	Baxter 0.9% NaCl		1000mL	14/case	\$79.00
#130121	Baxter 0.45% NaCl		1000mL	1/each	\$2.99
#130123bx*	Bacteriostatic 0.9% Sodium Chloride	Vial	30mL	25/box	\$39.99
#130127	0.9% Sodium Chloride Injection	Vial	10mL	1/each	\$1.99



#130103



#130123bx

DEXTROSE/RINGERS

#130115	Baxter 5% Dextrose & Water		50mL	1/each	\$2.25
#130114	Baxter 5% Dextrose & Water		250mL	1/each	\$2.35
#130113	Baxter 5% Dextrose & Water		500mL	1/each	\$2.45
#130112*	Baxter 5% Dextrose & Water		1000mL	1/each	\$2.55
#130112cs	Baxter 5% Dextrose & Water		1000mL	14/case	\$59.99
#130116	Baxter 5% Dextrose & 0.9% NaCl	Vial	1000mL	1/each	\$2.45
#130118	Baxter 5% Dextrose & 0.45% NaCl		500mL	1/each	\$2.65
#130120	Baxter Lactated Ringer's Solution		500mL	1/each	\$1.99
#130119	Baxter Lactated Ringer's Solution		1000mL	1/each	\$5.99



#130112

*Shown

Infusion

IV CATHETERS



#201220bx

smiths medical PROTECTIV® PLUS SAFETY IV CATHETERS

- Compatible with customary technique
- Radiopaque; polyurethane

#201221bx	14g x 1-1/4"	Orange	50/box	\$169.95
#201216bx	16g x 1-1/4"	Gray	50/box	\$169.95
#201218bx	18g x 1-1/4"	Green	50/box	\$169.95
#201220bx	20g x 1"	Pink	50/box	\$169.95
#201219bx	20g x 1-1/4"	Pink	50/box	\$169.95
#201215bx	22g x 1"	Blue	50/box	\$169.95
#201217bx	24g x 3/4"	Yellow	50/box	\$169.95



#201227bx

smiths medical PROTECTIV® PLUS SAFETY WINGED IV CATHETERS (with Teflon®)

- Compatible with customary technique

#201228bx	14g x 1-1/4"	Orange	50/box	\$179.95
#201223bx	16g x 1-1/4"	Gray	50/box	\$179.95
#201225bx	18g x 1-1/4"	Green	50/box	\$179.95
#201227bx	20g x 1"	Pink	50/box	\$179.95
#201226bx	20g x 1-1/4"	Pink	50/box	\$179.95
#201222bx	22g x 1"	Blue	50/box	\$179.95
#201224bx	24g x 3/4"	Yellow	50/box	\$179.95



smiths medical PROTECTIV® SAFETY IV CATHETERS (With Radiopaque FEP Polymer)

- Compatible with customary technique
- Radiopaque; polyurethane

#201213bx	16g x 1-1/4"	Gray	50/box	\$115.00
#201201bx	18g x 1-1/4"	Green	50/box	\$115.00
#201203bx	20g x 1"	Pink	50/box	\$115.00
#201202bx	20g x 1-1/4"	Pink	50/box	\$115.00
#201204bx	22g x 1"	Blue	50/box	\$115.00
#201205bx	24g x 3/4"	Yellow	50/box	\$115.00

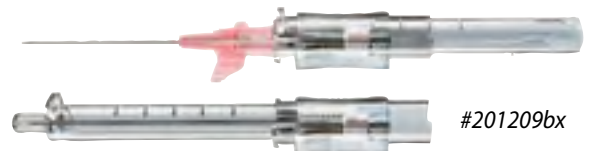

#201209bx

smiths medical PROTECTIV® PLUS-W SAFETY WINGED IV CATHETERS

- Compatible with customary technique
- Radiopaque; polyurethane

#201206bx	14g x 1-1/4"	Orange	50/box	\$119.00
#201207bx	16g x 1-1/4"	Gray	50/box	\$119.00
#201208bx	18g x 1-1/4"	Green	50/box	\$119.00
#201209bx	20g x 1"	Pink	50/box	\$119.00
#201210bx	20g x 1-1/4"	Pink	50/box	\$119.00
#201211bx	22g x 1"	Blue	50/box	\$119.00
#201212bx	24g x 5/8"	Yellow	50/box	\$119.00

IV CATHETERS



#130530bx

INSYTE-N™ AUTOGUARD™ BD SHIELDED (Wingless)

#130533bx	14g x 1.75"	Orange	50/box	\$149.00
#130531bx	16g x 1.16"	Gray	50/box	\$149.00
#130532bx	16g x 1.77"	Gray	50/box	\$149.00
#130529bx	18g x 1.16"	Green	50/box	\$135.00
#130530bx	18g x 1.88"	Green	50/box	\$135.00
#130527bx	20g x 1"	Pink	50/box	\$135.00
#130508bx	20g x 1.16"	Pink	50/box	\$135.00
#130528bx	20g x 1.88"	Pink	50/box	\$135.00
#130507bx	22g x 1"	Blue	50/box	\$135.00
#130543bx	24g x 0.56"	Yellow	50/box	\$199.00
#130526bx	24g x 1.88"	Yellow	50/box	\$135.00



#130537bx

INSYTE-N AUTOGUARD BD SHIELDED (Winged)

#130540bx	16g x 1.16"	Gray	50/box	\$135.00
#130546bx	16g x 1.77"	Gray	50/box	\$149.00
#130538bx	18g x 1.16"	Green	50/box	\$149.00
#130539bx	18g x 1.88"	Green	50/box	\$135.00
#130537bx	20g x 1"	Pink	50/box	\$135.00
#130544bx	20g x 1.16"	Blue	50/box	\$135.00
#130545bx	20g x 1.88"	Pink	50/box	\$135.00
#130536bx	22g x 1"	Blue	50/box	\$135.00
#130534bx	24g x 0.56"	Yellow	50/box	\$199.00
#130535bx	24g x 1.88"	Yellow	50/box	\$135.00



#130548bx

INSYTE™ AUTOGUARD™ BC SHIELDED (Wingless)

#130553bx	16g x 1.16"	Gray	50/box	\$149.00
#130554bx	16g x 1.77"	Gray	50/box	\$149.00
#130551bx	18g x 1.16"	Green	50/box	\$135.00
#130552bx	18g x 1.88"	Green	50/box	\$135.00
#130549bx	20g x 1"	Pink	50/box	\$135.00
#130541bx	20g x 1.16"	Pink	50/box	\$135.00
#130550bx	20g x 1.88"	Pink	50/box	\$135.00
#130548bx	22g x 1"	Blue	50/box	\$135.00
#130547bx	24g x 0.75"	Yellow	50/box	\$135.00



#130557bx

INSYTE™ AUTOGUARD™ BC SHIELDED (Winged)

#130562bx	16g x 1.16"	Gray	50/box	\$149.00
#130563bx	16g x 1.77"	Gray	50/box	\$149.00
#130560bx	18g x 1.16"	Green	50/box	\$135.00
#130561bx	18g x 1.88"	Green	50/box	\$135.00
#130557bx	20g x 1"	Pink	50/box	\$135.00
#130558bx	20g x 1.16"	Pink	50/box	\$135.00
#130559bx	20g x 1.88"	Pink	50/box	\$135.00
#130556bx	22g x 1"	Blue	50/box	\$135.00
#130555bx	24g x 0.75"	Yellow	50/box	\$135.00

Infusion

IV CATHETERS



TERUMO SURFLASH® IV POLYURETHANE CATHETERS

#130564bx	14g x 2"	Orange	50/box	\$69.00
#130565bx	16g x 2"	Gray	50/box	\$69.00
#130566bx	16g x 2-1/2"	Gray	50/box	\$69.00
#130567bx	18g x 1-1/4"	Green	50/box	\$69.00
#130568bx	18g x 2-1/2"	Green	50/box	\$69.00
#130569bx	20g x 1"	Pink	50/box	\$69.00
#130570bx	20g x 1-1/4"	Pink	50/box	\$69.00
#130571bx	20g x 2"	Pink	50/box	\$69.00
#130572bx	22g x 1"	Blue	50/box	\$69.00
#130573bx	24g x 3/4"	Yellow	50/box	\$69.00



TERUMO SURFLO® PTFE IV CATHETERS

#130574bx	14g x 2"	Orange	50/box	\$65.00
#130575bx	16g x 1-1/4"	Gray	50/box	\$65.00
#130576bx	16g x 2"	Gray	50/box	\$65.00
#130577bx	16g x 2-1/2"	Gray	50/box	\$65.00
#130578bx	18g x 2"	Green	50/box	\$65.00
#130579bx	18g x 2-1/2"	Green	50/box	\$65.00
#130580bx	18g x 1-1/4"	Green	50/box	\$65.00
#130581bx	20g x 1"	Pink	50/box	\$65.00
#130542bx	20g x 1-1/4"	Pink	50/box	\$65.00
#130582bx	20g x 2"	Pink	50/box	\$65.00
#130583bx	22g x 1"	Blue	50/box	\$65.00
#130584bx	24g x 3/4"	Yellow	50/box	\$65.00



TERUMO SURFLASH® SAFETY IV CATHETERS

#130514bx	18g x 1-1/4"	Green	50/box	\$125.00
#130515bx	20g x 1"	Pink	50/box	\$125.00
#130516bx	20g x 1-1/4"	Pink	50/box	\$125.00
#130517bx	22g x 1"	Blue	50/box	\$125.00
#130518bx	22g x 1-1/4"	Blue	50/box	\$125.00
#130519bx	24g x 3/4"	Yellow	50/box	\$125.00



EXEL IV CATHETER (Wingless)

• Teflon®

#130502bx	16g x 1-1/4"	Lt Green	50/box	\$39.95
#130503bx	18g x 1-1/4"	Pink	50/box	\$39.95
#130504bx	20g x 1-1/4"	Yellow	50/box	\$39.95
#130505bx	22g x 1"	Black	50/box	\$39.95
#130506bx	24g x 3/4"	Red	50/box	\$39.95
#130502bx	16g x 1-1/4"	Lt Green	50/box	\$39.95

BLOOD COLLECTION

smiths SAF-T WING BLOOD COLLECTION SETS

#130639bx	21g x 3/4"	6" Tubing	50/box	\$69.99
#130640bx	21g x 3/4"	12" Tubing	50/box	\$69.99
#130641bx	23g x 3/4"	6" Tubing	50/box	\$69.99
#130642bx	23g x 3/4"	12" Tubing	50/box	\$69.99
#130643bx	25g x 3/4"	6" Tubing	50/box	\$69.99
#130644bx	25g x 3/4"	12" Tubing	50/box	\$69.99



#130639bx

smiths WITH SAF-T HOLDER®

#130645bx	21g x 3/4"	6" Tubing	50/box	\$109.00
#130604bx	21g x 3/4"	12" Tubing	50/box	\$115.00
#130323bx	23g x 3/4"	6" Tubing	50/box	\$115.00
#130605bx	23g x 3/4"	12" Tubing	50/box	\$115.00
#130646bx	25g x 3/4"	6" Tubing	50/box	\$115.00
#130606bx	25g x 3/4"	12" Tubing	50/box	\$115.00



#130654bx

smiths SAF-T HOLDER® DEVICE

#130607bx	Saf-T Holder with Male Luer Adaptor	50/box	\$89.00
#130608bx	Saf-T Holder with Female Luer Adaptor	50/box	\$89.00
#130610bx	Male Luer Lock Adaptor	50/box	\$69.00
#130609bx	Pediatric Tube Insert	10/box	\$2.70



#130607bx

smiths VENIPUNCTURE NEEDLE-PRO®

#130611bx	Needle-Pro Device	25/box	\$4.99
-----------	-------------------	--------	---------------



#130611bx

Infusion

BLOOD COLLECTION



EXEL SECURETOUCH SAFETY BUTTERFLY INFUSION SETS

#130647bx	21g x 3/4"	12" Tubing	50/box	\$29.99
#130621bx	23g x 3/4"	12" Tubing	50/box	\$29.99



EXEL SCALP VEIN BUTTERFLY SETS

#130648bx	19g x 3/4"	12" Tubing	50/box	\$14.99
#130649bx	20g x 3/4"	12" Tubing	50/box	\$14.99
#130650bx	21g x 3/4"	12" Tubing	50/box	\$14.99
#130619bx	23g x 3/4"	12" Tubing	50/box	\$14.99
#130620bx	25g x 3/4"	12" Tubing	50/box	\$14.99
#130651bx	27g x 3/4"	12" Tubing	50/box	\$14.99



#130623bx

EXEL LATEX-FREE MULTI SAMPLE LUER ADAPTER (Sterile)

#130623bx	Adapter	100/box	\$14.50
#121138pk	Clear Luer Holder, 5mL	100/pack	\$11.50



#130612bx

BD VACUTAINER PUSH BUTTON BLOOD COLLECTION SETS

#130652bx	With Luer Adapter 25g x 3/4"	7" Tubing	50/box	\$105.00
#130654bx	Safety Retracting 21g x 3/4"	7" Tubing	50/box	\$105.00
#130637bx	Safety Retracting 21g x 3/4"	12" Tubing	50/box	\$99.00
#130653bx	Safety Retracting 23g x 3/4"	7" Tubing	50/box	\$105.00
#130624bx	Safety Retracting 23g x 3/4"	12" Tubing	50/box	\$99.00
#130655bx	Safety Retracting 25g x 3/4"	12" Tubing	50/box	\$105.00
#130612bx	Clear Needle Holder	250/box	\$14.95	

BLOOD COLLECTION

BD VACUTAINER WITH CONVENTIONAL STOPPER AND PAPER LABELS

#130656pk	13 x 100mm, 6.0mL Plastic Tube, Red Stopper	100/pack	\$24.50
#130657pk	13 x 100mm, 6.0ml Plastic Tube Lavender Stopper	100/pack	\$29.99



BD VACUTAINER CITRATE PLUS PLASTIC TUBES WITH HEMOGARD CLOSURE

#130638bx	13mm x 75mm, 2.7mm Blue Paper Label	100/box	\$19.99
-----------	--	---------	----------------



BD VACUTAINER NO ADDITIVE PLASTIC TUBES WITH HEMOGARD CLOSURE

#130658bx	13 x 75mm, 3.0mL Clear Paper Label	100/box	\$19.99
-----------	---------------------------------------	---------	----------------



BD VACUTAINER PLUS LITHIUM HEPARIN PLASTIC TUBES WITH HEMOGARD CLOSURE

#130659bx	13 x 75mm, 2mL Green Paper Label	100/box	\$19.99
-----------	-------------------------------------	---------	----------------



TOURNIQUETS

#130601	Latex Free	1/each	\$0.25
#130602	Adult Rubber/Velcro	1/each	\$2.75
#130603	Child Rubber/Velcro	1/each	\$2.75











SPINAL NEEDLES

#130615	18g x 3-1/2", Pink	1/each	\$1.99
#130616	20g x 3-1/2", Yellow	1/each	\$1.99
#130617	22g x 3-1/2", Black	1/each	\$1.99
#130618	25g x 3-1/2", Orange	1/each	\$1.99





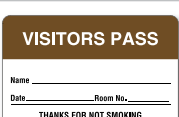





Labels

ADMISSIONS











	ADMISSIONS	ITEM #	DESCRIPTION	SIZE	QTY	PRICE
		#290729rl	Visitors Pass (Red)	1-3/4" x 2-3/4"	500/roll	\$18.37
		#290730rl	Visitors Pass (Black)	1-3/4" x 2-3/4"	500/roll	\$18.37
		#290731rl	Visitors Pass (Purple)	1-3/4" x 2-3/4"	500/roll	\$18.37
		#290732rl	Visitors Pass (Blue)	1-3/4" x 2-3/4"	500/roll	\$18.37
		#290733rl	Visitors Pass (Orange)	1-3/4" x 2-3/4"	500/roll	\$18.37
		#290734rl	Visitors Pass (Green)	1-3/4" x 2-3/4"	500/roll	\$18.37
		#290735rl	Visitors Pass (Brown)	1-3/4" x 2-3/4"	500/roll	\$18.37
		#290721pk	Expiring Visitor Pass Book	2-7/8" x 1-7/8"	50/pack	\$60.09
		#290736pk	HIPAA-Compliant Sign-in Sheet	23 labels/sheet	100 sheets /pack	\$33.38

ALLERGY

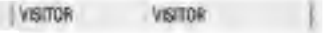
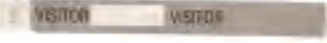



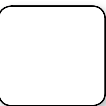







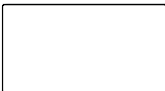

ALLERGY	ITEM #	DESCRIPTION	SIZE	QTY	PRICE
	#290441rl	Egg Allergy	2-1/2" round	100/roll	\$6.19
	#290442rl	Dairy Allergy	2-1/2" round	100/roll	\$6.19
	#290443rl	Peanut Allergy	2-1/2" round	100/roll	\$6.19
	#290444rl	Shellfish Allergy	2-1/2" round	100/roll	\$6.19
	#290122pk	Adult Patient Allergy Wristband (Red)	11" x 1-1/8"	50/pack	\$14.04
	#290102pk	Allergy Alert	2-1/2" x 2-1/2"	380/roll	\$24.19
	#290103rl	Allergy Alert Tape	6" x 1"	500/roll	\$8.69
	#290101rl	Allergy Warning	5-1/2" x 1"	175/roll	\$17.63
	#290104rl	Latex Allergy Alert (Green)	2-1/4" x 7/8"	420/roll	\$17.99

Labels

GENERAL OFFICE





	GENERAL OFFICE	ITEM #	DESCRIPTION	SIZE	QTY	PRICE
Diagnosics		#290207pk	UniArrow Flag (Light Blue)	2-1/4" x 9/16"	150/pack	\$5.99
Gloves		#290208pk	UniArrow Flag (Pink)	2-1/4" x 9/16"	150/pack	\$5.99
Hospital Beds		#290209pk	UniArrow Flag (Red)	2-1/4" x 9/16"	150/pack	\$5.99
Infusion	Tyvek®					
		#290722bx	Tyvek Visitor Wristband (Blue)	10" x 1"	500/box	\$24.99
		#290723bx	Tyvek Visitor Wristband (Green)	10" x 1"	500/box	\$24.99
		#290728bx	Tyvek Visitor Wristband (White)	10" x 1"	500/box	\$24.99
		#290724bx	Tyvek Visitor Wristband (Gray)	10" x 1"	500/box	\$24.99
		#290725bx	Tyvek Visitor Wristband (Pink)	10" x 1"	500/box	\$24.99
		#290726bx	Tyvek Visitor Wristband (Purple)	10" x 1"	500/box	\$24.99
		#290727bx	Tyvek Visitor Wristband (Red)	10" x 1"	500/box	\$24.99
Patient Room		#290720bg	Tyvek Waterproof Wristband (White)	4-1/4" x 10-3/4"	50/bag	\$14.39
Practice Meds	Dymo® (Labelwriter Compatible)					
PYXIS®		#290212rl	Dymo Labelwriter Printer Compatible (White)	1" x 1"	750/roll	\$12.44
Respiratory		#290213rl	Dymo Labelwriter Printer Compatible	2-1/8" x 2-3/4"	500/roll	\$17.84
Student Kits		#290216pk	Dymo Labelwriter Printer Compatible	3-1/2" x 1-1/8"	350/roll 2/pack	\$21.89

GENERAL OFFICE, INFECTION





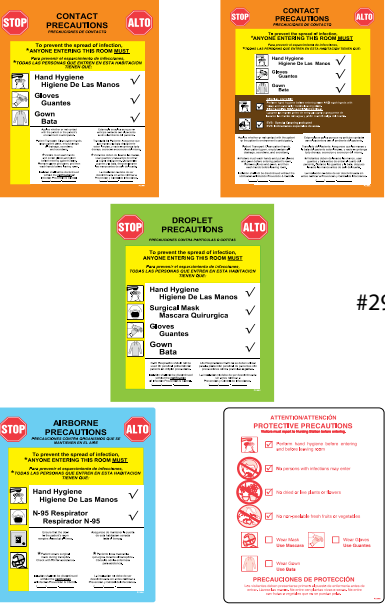





GENERAL OFFICE	ITEM #	DESCRIPTION	SIZE	QTY	PRICE
	#290214rl	 Thermal for Labelwriter	1-3/16" x 3-1/16"	500/roll	\$17.84
	#290215rl	 Thermal for Labelwriter	1-15/16 " x 3-1/2"	400/roll	\$14.19
	#290217pk	 Thermal For Labelwriter	1-1/8" x 3-7/16"	130/roll 2 rolls/pack	\$8.24
	#290218rl	 Thermal For Labelwriter	2-5/16" x 4"	400/roll	\$14.99
	#290219rl	 Printer Compatible	1" x 2-1/8"	500/roll	\$14.64
	#290220rl	 Printer Compatible	3/4" x 2"	500/roll	\$10.24
INFECTION	ITEM #	DESCRIPTION	SIZE	QTY	PRICE
	#290647pk	Hand Hygiene Removable <i>Hand Hygiene Saves Lives</i>	6" x 6"	50/pack	\$21.29
	#290648pk	Hand Hygiene <i>It's Ok To Ask</i>	6" x 6"	50/pack	\$21.29
	#290649pk	Handwashing Techniques	6" x 6"	10/pack	\$18.99

Labels

INFECTION

INFECTION <i>Continued</i>	ITEM #	DESCRIPTION	SIZE	QTY	PRICE
	#290652pk	Biohazard Warning	3" x 3"	20/pack	\$18.09
	#290653pk	GHS Hazard	2-1/2" x 2-1/2"	50/pack	\$10.99
	#290650rl	Hand Hygiene <i>Ask Wash Hands</i>	2-1/2" round	200/roll	\$11.59
	#290651kt	Precautions Signs Kit 5 each of 5 posters	8-3/4" x 10-7/8"	25/kits	\$26.99
	#290105rl	Stat (Red)	1-1/4" x 5/16"	760/roll	\$10.13
	#290106rl	Flu (Yellow)	1/2" round	250/roll	\$12.99

NURSING







NURSING	ITEM #	DESCRIPTION	SIZE	QTY	PRICE
	#290340rl	Patient Charge System (Sterile)	15/16" x 5/8"	800/roll	\$13.99
	#290155rl	Change Minder Sunday (Pink)	3" x 7/8"	320/roll	\$16.59
	#290156rl	Change Minder Monday (Orange)	3" x 7/8"	320/roll	\$16.59
	#290157rl	Change Minder Tuesday (Green)	3" x 7/8"	320/roll	\$16.59
	#290158rl	Change Minder Wednesday (Yellow)	3" x 7/8"	320/roll	\$16.59
	#290159rl	Change Minder Thursday (Blue)	3" x 7/8"	320/roll	\$16.59
	#290160rl	Change Minder Friday (Tan)	3" x 7/8"	320/roll	\$16.59
	#290161rl	Change Minder Saturday (Red)	3" x 7/8"	320/roll	\$16.59
	#290162pk	Change Minder Set Sunday-Saturday	3" x 7/8"	7rolls/set	\$92.89
	#290339rl	Sterilization (Green)	4" x 1-7/8"	240/roll	\$21.94
	#290163rl	Tubing Change 24 Hour Change (Pink)	3" x 7/8"	320/roll	\$15.49

Labels

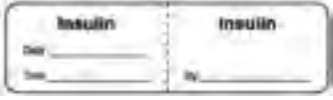
NURSING

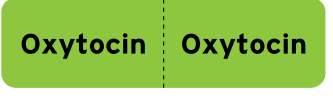



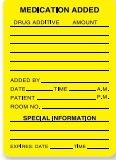
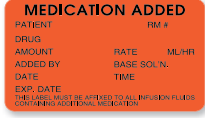
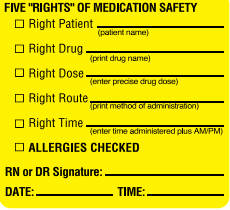



NURSING	ITEM #	DESCRIPTION	SIZE	QTY	PRICE
	#290164rl	IV Tubing Change 24 Hours Only (Pink)	3" x 1"	885/roll	\$23.39
	#290165rl	IV Tubing Change 48 Hours Only (Yellow)	1" x 3"	885/roll	\$23.39
	#290166rl	IV Tubing Change _Hours Only (Green)	1" x 3"	885/roll	\$23.39
	#290167rl	IV Tubing Changed (Orange)	1" x 3"	885/roll	\$23.39
	#290168rl	IV Tubing Changed _Hours Only (Red)	1" x 3"	885/roll	\$23.39
	#290169rl	IV Tubing Changed (Yellow)	1" x 3"	885/roll	\$23.39
	#290177rl	Chemotherapy Line Identification (Yellow)	3" x 7/8"	320/roll	\$15.49
	#290170rl	Dopamine Line Identification (Orange)	3" x 7/8"	320/roll	\$15.49
	#290123rl	Fentanyl IV Line Identification (Blue)	3" x 7/8"	320/roll	\$15.49
	#290171rl	Heparin Line Identification (Green)	3" x 7/8"	320/roll	\$15.49

NURSING











NURSING	ITEM #	DESCRIPTION	SIZE	QTY	PRICE
	#290127rl	Insulin IV Line Identification (White)	3" x 7/8"	320/roll	\$15.49
	#290125rl	Morphine IV Line Identification (Blue)	3" x 7/8"	320/roll	\$15.49
	#290175rl	Oxytocin Line Identification (Green)	3" x 7/8"	320/roll	\$15.49
	#290176rl	Pitocin Line Identification (Pink)	3" x 7/8"	320/roll	\$15.49
	#290172rl	TPN Line Identification (Pink)	3" x 7/8"	320/roll	\$15.49
	#290178rl	Anesthesia Saline (White)	1-1/4" x 5/16"	760/roll	\$15.49
	#290179rl	Coumadin Line Identification (Pink)	1-1/4" x 5/16"	760/roll	\$15.49
	#290180rl	IV Medication Added (Yellow)	2" x 3"	320/roll	\$22.49
	#290181rl	IV Medication Added (Orange)	2-1/2" x 1-1/2"	600/roll	\$24.79
	#290182rl	Medication Safety Five Rights	3" x 3"	320/roll	\$22.49

Labels

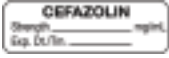
NURSING

	NURSING	ITEM #	DESCRIPTION	SIZE	QTY	PRICE
		#290183rl	Fall Precautions	2-3/8" x 1-3/4"	400/roll	\$22.49
		#290184rl	Fall Risk (Orange)	1-1/4" x 5/16"	760/roll	\$10.65
		#290185rl	<i>Hug Me I Was Great</i> Kid's Sticker	2-1/2" round	100/roll	\$6.19
		#290186rl	<i>I Was Good Today I'm Not Lion</i> Kid's Sticker	2-1/2" round	100/roll	\$6.19
		#290187rl	<i>I'm A Big Brother</i> Kid's Sticker	3" x 2"	200/roll	\$11.94
		#290188rl	<i>I'm A Big Sister</i> Kid's Sticker	3" x 2"	200/roll	\$11.94
		#290189rl	<i>I've Grown!</i> <i>Date___, Inches___, Lbs___</i> Kid's Sticker	2-1/2" round	200/roll	\$11.94
		#290190rl	<i>Got Flu Shot</i> Kid's Sticker	2-1/2" round	200/roll	\$11.94
		#290191rl	Flumazenil Anesthesia mg/mL	1-1/2" x 1/2"	610/roll	\$11.99





NURSING

NURSING	ITEM #	DESCRIPTION	SIZE	QTY	PRICE
	#290128rl	Dexmedetomidine Anesthesia mcg/mL	1-1/2" x 1/2"	610/roll	\$11.99
	#290129rl	Lidocaine Anesthesia 20 mg/mL	1-1/2" x 1/2"	610/roll	\$11.99
	#290130rl	Epinephrine Anesthesia 10 mcg/mL	1-1/2" x 1/2"	610/roll	\$11.99
	#290131rl	Dilaudid Anesthesia 1 mg/mL	1-1/2" x 1/2"	610/roll	\$11.99
	#290132rl	Cefazolin Anesthesia mg/mL	1-1/2" x 1/2"	610/roll	\$11.99
	#290133rl	Midazolam Anesthesia 5 mg/mL	1-1/2" x 1/2"	610/roll	\$11.99
	#290134rl	Duramorph Anesthesia mg/mL	1-1/2" x 1/2"	610/roll	\$11.99
	#290135rl	Neosynephrine Anesthesia 100 mg/mL	1-1/2" x 1/2"	610/roll	\$11.99
	#290136rl	Dextrose 5% Anesthesia (White)	1-1/2" x 1/2"	610/roll	\$11.99
	#290137rl	Ropivacaine Anesthesia 0.5 mg/mL	1-1/2" x 1/2"	610/roll	\$11.99
	#290138rl	Midazolam Anesthesia mg/mL	3" X 1"	500/roll	\$19.99



Labels

NURSING, PHARMACY





NURSING

ITEM #	DESCRIPTION	SIZE	QTY	PRICE
 #290139rl	Morphine Anesthesia mg/mL	3" X 1"	500/roll	\$19.99
 #290140rl	Hydromorphone Anesthesia mg/mL	3" X 1"	500/roll	\$19.99
 #290141rl	Fentanyl Anesthesia mg/mL	3" X 1"	500/roll	\$19.99
 #290145rl	Ketalorac Anesthesia mg/mL	3" X 1"	500/roll	\$19.99

Tape Dispensers



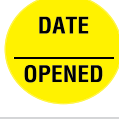



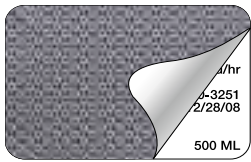

ITEM #	DESCRIPTION	SIZE	QTY	PRICE
 #290211	Plastic Dispenser without Insert	14-1/2" x 4"	1/each	\$51.49
 #290210	Plastic Dispenser	14-1/2" x 4"	1/each	\$81.89

PHARMACY

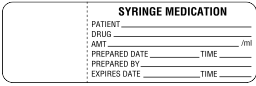
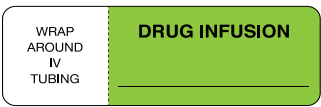
ITEM #	DESCRIPTION	SIZE	QTY	PRICE
 #290538rl	Clear Label Protector	2-1/2" x 1-1/4"	725/roll	\$24.99
 #290537rl	Clear Label Protector	2-1/2" x 1-1/2"	590/roll	\$24.99
 #290545rl	Expiration Date	3/4" round	570/roll	\$16.19
 #290546rl	Date Opened	3/4" round	570/roll	\$16.19
 #290554cs	Pyxis Direct Thermal Paper Rolls	4-1/2" x 100'	100'/roll 50 rolls/case	\$82.74

PHARMACY

PHARMACY *Continued*

	ITEM #	DESCRIPTION	SIZE	QTY	PRICE
	#290591rl	Blockout Label	3" x 2"	500/roll	\$17.64
	#290592rl	Blockout Label	4" x 2"	500/roll	\$18.79
	#290593rl	Date Opened (White)	3" x 1"	500/roll	\$21.99
	#290594rl	Syringe Medication (White)	3" x 1"	500/roll	\$21.99
	#290595rl	Drug Infusion	3" x 1"	500/roll	\$21.99
	#290596rl	Dose Indicating Fill Line	1-1/2" x 1/2"	500/roll	\$15.74
	#290597rl	Syringe Medication For Irrigation Only	2-1/4" x 7/8"	420/roll	\$17.99
	#290598rl	CAUTION: Look Alike/Sound Alike	3" x 1-5/8"	320/roll	\$21.94
	#290599rl	Storage and Quality Control Multi-Dose Vial <i>Discard after ___ days</i>	1-1/2" x 1/2"	610/roll	\$17.99
	#290536rl	Drug Anesthesia mg/mL	3" x 1"	500/roll	\$19.99
	#290535rl	Formalin 10% (White)	3" x 1-1/8"	320/roll	\$23.59

Manikins

PATIENT CARE MANIKIN

GERI™ COMPLETE MANIKIN

Elderly, full-sized adult manikin (58" length, 28 lbs)

Realistic skin wrinkles and folds, and complete lifelike range of motion

Male manikin converts to female with removal of wig and attachment of male genitals



Prepare students for:

- | | | | |
|---|--|--|--|
| <ul style="list-style-type: none"> • Visual inspection • Bed baths • Stage 1 sacral ulcer • Reddened skin folds • Bandaging • Clothing changes • Otic drops • Eye irrigation • Hair care washing | <ul style="list-style-type: none"> • Oral and nasal hygiene
<i>lavage, gavage, suctioning</i> • Tissue maintenance • Patient positioning • Pericare • Gastrostomy procedures • Urinary catheterization
<i>female, uncircumcised male</i> • Prostate exam, stage B • Nasogastric tube placement | <ul style="list-style-type: none"> • Normal/cancerous mole • Dilated/constricted pupils • Wound dressing • Denture placement and removal • Ear canal irrigation • Hearing aid placement • Finger/toe manipulation • Intramuscular injection
<i>arm, thigh, buttock</i> | <ul style="list-style-type: none"> • Ostomy care • Ileostomy and colostomy • Appliance application • Patient transfer • Tracheostomy care • Enema administration
<i>female only</i> • Pap smears • Douching • Internal fluid reservoirs |
|---|--|--|--|

#190501	Geri™ Complete Manikin	\$1,700.00
#190503	Soft Carry Bag Only	\$138.00

GERI™ BASIC MANIKIN

- Offers all the features of the Complete Manikin (*above*) without internal fluid reservoirs and without urinary catheterization
- 58" length; 28 lbs
- Three-year warranty

#190505	Geri™ Basic Manikin	\$1,350.00
#190503	Soft Carry Bag Only	\$138.00



Great Value



GERI™ ADVANCED MANIKIN

- Includes all the features of the Complete Manikin (*above*)—plus (1) right IV Training Arm and (1) left Blood Pressure Arm

#190904	Geri™ Advanced Manikin	\$2,775.00
---------	------------------------	-------------------

PATIENT CARE MANIKIN

KERI™ NURSING SKILLS MANIKINS

Keri™ is an adult-sized manikin (58" length, 28 lbs) that has a non-age-specific appearance and complete lifelike range of motion. Patients can learn:

- Normal and cancerous mole
- Stage 1 sacral ulcer
- Dilated/constricted pupils
- Reddened skin folds
- Bandaging, wound dressing
- Bed baths
- Clothing changes
- Denture placement, removal
- Ear canal irrigation
- Otic drop
- Hearing aid placement
- Eye irrigation
- Finger and toe manipulation with bandaging
- Hair care washing and combing
- Intramuscular injections *arm, thigh, buttock*
- Oral and nasal hygiene (*lavage, gavage, and suctioning*)
- Ostomy care
- Appliance application
- Patient transfer
- Pericare
- Tracheostomy care

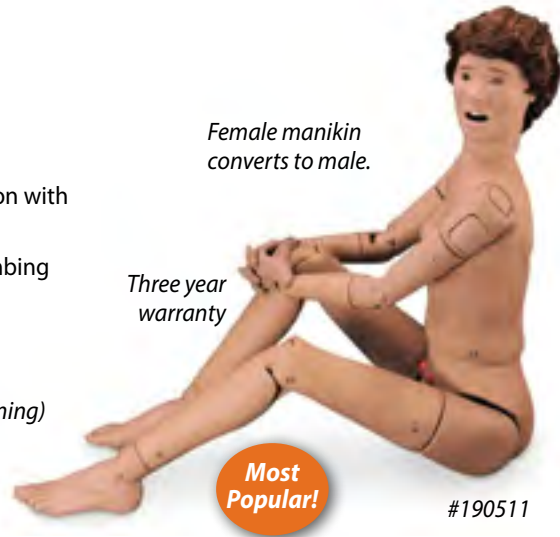

#190511

#190502	Keri™ Complete Manikin	Includes all the training features listed above	\$1,700.00
#190510	Keri™ Advanced Manikin	All of the above, plus (1) IV and (1) Blood Pressure Training Arm	\$2,775.00
#190511	Keri™ Basic Manikin	The economical option, all features minus internal fluid reservoirs and catheterization	\$1,350.00
#190503	Geri™ Soft Carry Bag Only		\$138.00

IV ARM ATTACHMENT

- Use with all Geri™ and Keri™ manikins
- IV arm attachment provide comprehensive IV training: realistic flashback that confirms proper needle placement, and latex veins that roll when palpated

#190506	IV Attachment Arm with Carry Case	\$545.00
#190507	Replacement IV Skin and Vein Kit	\$112.50



SPEAKER SYSTEM FOR BLOOD PRESSURE ARM

- Use with all Geri™ and Keri™ manikins
- Project the five Korotkoff phases: the appearance of tapping sounds; sounds that become softer/louder; sounds that become crisper/louder; sounds that become muffled/softer; and sounds that disappear

#190509	Speaker System	\$243.00
---------	----------------	-----------------



Manikins

INFANT, BIRTHING

Newborn male or female,
Caucasian or African American



SPECIAL NEEDS INFANT MANIKINS

Includes:

- Tracheostomy care (size 3 mm neonatal)
- Gastrostomy care (size 14 Fr)
- Nasogastric care (size 8 Fr or smaller)
- Colostomy stoma (basic)
- Urethral catheterization (size 8 Fr)
- Tracheostomy and gastrostomy tubes sold separately
- Three year warranty

#190306	Female, Caucasian/White	\$445.00
#190305	Male, Caucasian/White	\$445.00
#190303	Female, African American	\$445.00
#190304	Male, African American	\$445.00



Life/Form. BIRTHING STATION SIMULATOR

- Demonstration and practice of palpating the internal birthing canal
- Highlights the ischial spines
- Includes teaching guide and hard carry case
- Three year warranty

#190808	1/each	\$875.00
---------	--------	-----------------



BABY HIPPY

- Reproduction of the lower torso and limbs of a female newborn
- Dislocated left hip for practice of the Ortolani Jerk-sign
- Lax right hip for performing the Barlow Maneuver

#190809	1/each	\$516.00
---------	--------	-----------------



Life/Form. MICRO-PREEMIE SIMULATOR

- Includes diaper, hat, lubricant, 3cc syringe, 25g butterfly needle and blood powder. Hat color may vary. NG tube size 5Fr ET tube size 5mm ID.
- Three year warranty

#190806	White	1/each	\$265.00
#190807	Black	1/each	\$265.00



Life/Form. CERVICAL/EFFACEMENT DILATATION SIMULATORS

- Complete simulator set consists of (6) separate 5" x 5" x 5" pelvic blocks
- Includes pelvic blocks, teaching guide, and hard carrying case
- 21" x 14" x 7"
- Three year warranty

#190810	1/each	\$895.00
---------	--------	-----------------

EXAMINATION



BREAST EXAMINATION SIMULATOR

- Each breast contains abnormalities (a small nodule, a fibroadenoma, and a round lump movable discrete mass directly under the nipple)
- Includes teaching guide, exam brochure and storage box
- Three year warranty

#190201 1/each **\$455.00**



Life/Form. ADVANCED BREAST EXAM SIMULATOR

- Unlike other simulators, tissue density actually varies within the simulated breast
- Designed for supine or standing examination
- Three year warranty

#190207 1/each **\$615.00**



TESTICULAR EXAM SIMULATOR

- Soft, outer skin with four embedded, simulated tumors
- Includes baby powder, laminated tumor location and simulator care card, male self-exam brochure and storage box
- Three year warranty

#190202 1/each **\$135.00**



Life/Form. DIAGNOSTIC & PROCEDURAL EAR TRAINER WITH PNEUMATIC OTOSCOPY KIT

- Middle ear can be filled with various fluids
- Includes (2) ears, approximately (100) pre-cut eardrums, ear wax, (3) standard middle ear cartridges with syringe, adjustable stand, & hard carry case

#190348 1/each **\$1,035.00**

#190346 Pneumatic Kit Only **\$780.00**

#190347 Ear Trainer Only **\$404.00**



Life/Form. EAR EXAMINATION SIMULATOR AND BASIC NURSING SET

Includes:

- Normal tympanic membrane with slanted ear canal
- Normal tympanic membrane
- Mucoïd otitis media
- Serous otitis media with fluid level
- Chronic otitis media with perforation
- Normal ear without photo for earwax removal exercise
- (2) Tubes of synthetic earwax
- Set of (9) 35mm slides; instructions; and hard carrying case

#190349 1/each **\$835.00**

#190350 Supplementary Set **\$180.00**

Committed to Providing Quality Products

Manikins

OTOSIM



#190613

OPHTHOSIM™ OPHTHALMOSCOPY TRAINING & SIMULATION SYSTEM

Includes

- Base unit
- Eye
- Instrumented ophthalmoscope
- Control box
- Software package & manual
- Protective hard case
- One year warranty

#190613	OphthoSim System	\$9,999.00
#190614	OphthoSim Upgrade Kit	\$5,999.00



#190608

OTOSIM 2™ OTOSCOPY TRAINING & SIMULATION SYSTEM

- Improves the accuracy of diagnosing pathologies of the ear
- Tutorials and high resolution images provide significant content for further student skill development
- Includes: base unit, instrumented otoscope, control box, adult earforms (right & left ear), software & manual on USB key, protective hard case

#190608	OtoSim 2 System	\$9,999.00
#190609	OtoSim 2 Software & Hardware Upgrade Kit	\$5,999.00

OPHTHOSIM™

Students can practice their examination technique with monocular vision while viewing through a realistic simulated-eye, complete with an adjustable iris.

Since ophthalmoscopes only allow a portion of the retina to be viewed at any time, the OphthoSim™ tracks the motion & orientation of the user through an instrumented ophthalmoscope and displays the appropriate region of the retina.

OphthoSim™ instructors can interact with students by landmarking critical features of a pathology.

Unique features of the OphthoSim™ Ophthalmoscopy Training and Simulation System:

- OphthoSim™ Ophthalmoscope
- Realistic Eye Geometry
- OphthoSim™ Content
- OphthoSim™ Software

For more information, visit

<http://otosim.com/otosim-features/>

OTOSIM 2™

OtoSim 2™ is the upgraded version of OtoSim™ with new software and hardware, and increased capabilities:

Verify student progress via the instrumented otoscope.

Trainees can point with this device to complete the learning feedback loop.

Expand student knowledge through reviewing 380 high resolution images from the Hawke Library to instruct, practice, and test students. Further increase student capability through advanced quizzes with randomized, realistic clinical scenarios that test both medical and patient interaction skills.

Save instructor time by connecting up to 14 OtoSim units to a single trainer laptop to effectively instruct groups at the same time. Supplement classroom instruction with 150 pre-annotated images for self-directed learning.

Better Eye and Ear Training, Better Outcome

INJECTION

INTRADERMAL INJECTION TRAINER

- Skin is made of soft silicon that leaves no needle marks

#190636	Intradermal Injection Trainer	1/each	\$800.00
---------	-------------------------------	--------	-----------------

SUBCUTANEOUS INJECTION TRAINER

- Skin is made of soft silicon that leaves no needle marks
- Easy installation, handling and cleaning

#190637	Subcutaneous Injection Trainer	1/each	\$350.00
---------	--------------------------------	--------	-----------------

INJECTION PAD TRAINER WITH STRAP

- Reasonably priced, compact
- Provide students with a realistic injection experience

#190307	Injection Pad Trainer with Strap	1/each	\$9.99
---------	----------------------------------	--------	---------------

Life/Form. INJECTION TRAINING MODEL

- Puncture repeatedly without showing needle holes
- Three year warranty

#190214	White Injection Training Model	1/each	\$55.00
---------	--------------------------------	--------	----------------

#190215	Black Injection Training Model	1/each	\$55.00
---------	--------------------------------	--------	----------------

Life/Form. INJECTION BELLY

- Teach patients how to properly insert and rotate the infusion set for insulin pumps
- Lifelike skin; feels like real stomach tissue underneath

#190208	Injection Belly	1/each	\$84.25
---------	-----------------	--------	----------------

Life/Form. VENATECH IM & SUB Q SIMULATOR

- Fits on the area of the deltoid muscle as well as the vastus lateralis, rectus femoris, ventrogluteal, and dorsogluteal areas

#190203	Light Skin Simulator	1/each	\$81.00
---------	----------------------	--------	----------------

#190204	Dark Skin Simulator	1/each	\$81.00
---------	---------------------	--------	----------------

Life/Form. INTRADERMAL INJECTION SIMULATOR

- Casting molded from a real forearm from the wrist, to just below the elbow
- Features 8 sites for practicing intracutaneous injections

#190205	Intradermal Injection Simulator	1/each	\$210.00
---------	---------------------------------	--------	-----------------

Life/Form. TB TESTING ARM

- Duplicate positive and negative TB reactions
- Includes both black and beige models, plus sizing card

#190209	TB Testing Arm	1/each	\$81.10
---------	----------------	--------	----------------



Manikins

IV TRAINERS



ADVANCED VENIPUNCTURE AND INJECTION ARM

- Complete venous access for IV therapy and phlebotomy, with 8-line vascular system and (1) external fluid bag supplying artificial blood to all veins simultaneously
- Replaceable skin and veins

#190302	Caucasian/White with Carry Case	\$625.00
#190301	African American with Carry Case	\$625.00



SKIN AND VEIN REPLACEMENT KIT

- Replaceable skin and vein kit for the Advanced Venipuncture and injection arm

#190308	Caucasian/White	\$172.00
#190309	African American	\$172.00
#190310	Replacement Bag	\$19.00
#190311	Tubing and Lubricant	\$112.00



BTUSA INTRAMUSCULAR INJECTION BUTTOCKS

- Composed of epidermis layer, muscular layer and skeletal frame
- Touchscreen type user interface with tablet PC
- Self training and evaluation mode are supplied
- Animated video and guidelines for injection procedures are supplied

#190635	1/each	\$6,000.00
---------	--------	-------------------



Life/Form. SPINAL INJECTION SIMULATOR

- Techniques include spinal anesthesia, spinal tap, epidural analgesia, caudal analgesia, sacral nerve block, and lumbar sympathetic block
- Replaceable skin can be changed without tools in minutes
- Includes a fluid supply bag with connectors, teaching guide, and hard carry case

#190316	1/each	\$1,035.00
---------	--------	-------------------



Life/Form. INTRAMUSCULAR INJECTION SIMULATOR

- Skin and muscle textures, bone shape and position, closely resemble a live patient
- Three types of intramuscular injections can be taught: dorsogluteal, ventrogluteal, and vastus lateralis injections
- Three year warranty

#190206	1/each	\$605.00
---------	--------	-----------------



Life/Form. PEDIATRIC HEAD

- For demonstrating and practicing infusions and injections
- Includes a Life/form® Head with skin and veins, fluid supply bag, (2) different gauge winged infusion needles, (1) pint Life/form® blood, teaching guide, and hard carry case
- 19" x 10" x 5"
- Three year warranty

#190802	1/each	\$455.00
---------	--------	-----------------

IV TRAINERS



BTUSA INTRAVENOUS INJECTION ARM 1

- Actual resistance feeling on the skin and venous wall
- Skin pad is composed of epidermis/subcutaneous fat/vein
- Easy installation and replacement of skin pad
- AC power or battery mode

#190632 1/each **\$2,500.00**



BTUSA INTRAVENOUS INJECTION ARM 2

- Actual resistance feeling on the skin and venous wall
- Skin pad is composed of epidermis/subcutaneous fat/vein
- Easy installation and replacement of skin pad
- AC power or battery mode, one-touch connection of tube

#190633 1/each **\$2,700.00**



Life/Form. IV DEMONSTRATION ARM

- Economical venipuncture and injection demonstration arm
- Constructed of soft material with lifelike veins in the skin surface
- Intramuscular injections can be practiced in the deltoid region
- 32" x 7" x 7"
- Three year warranty

#190337 1/each **\$190.00**



Life/Form. ADVANCED IV HAND

- Dorsal surface includes injectable metacarpal, digital, and thumb veins
- Skin pad is composed of epidermis/subcutaneous fat/vein
- Includes (1) pint simulated blood, (2) IV bags, butterfly set, 3cc syringe, 12cc syringe, and 22-gauge needle
- Three year warranty

#190210 Caucasian Hand 1/each **\$283.00**

#190211 African American Hand 1/each **\$283.00**

Manikins

IV TRAINER, LUMBAR PUNCTURE, CVC



Life/form. CANINE IV LEG

- For bandaging and restraint/assistance practice
- Represents the left foreleg of a medium-sized dog, and features (2) interchangeable sleeves; normal fur and shaved
- Includes a portable storage box with built-in IV pole, blood powder, syringe, IV catheter, and (2) fluid supply bags

#190701	Canine IV Leg	\$205.00
---------	---------------	-----------------



Life/form. VENATECH IV TRAINER

- For practicing starting IVs in a moving ambulance
- Includes the three main veins used in phlebotomy - cephalic, basilic, and median cubital, all in correct anatomical position
- Trainer measures 6-3/4" x 3-1/4" x 1"
- Three-year warranty

#190212	White	1/each	\$63.00
#190213	Black	1/each	\$63.00



Life/form. PEDIATRIC LUMBAR PUNCTURE SIMULATOR

- Represents a 10–12 month old infant placed in a left lateral decubitus position with the neck and knees flexed, approximating the necessary fetal position
- Practice this delicate procedure on a simulator that is anatomically accurate
- Infant measures 19" L x 7" W x 6" H, and the board measures 19-1/2" L x 11" W
- Three year warranty

#190805	1/each	\$525.00
---------	--------	-----------------



Life/form. CENTRAL VENOUS CANNULATION SIMULATOR

- Includes a replaceable muscle and bone section, subclavian, internal jugular, external jugular, and carotid
- Includes fluid supply bags, replaceable skin, needles, (1) quart of Life/form® blood, and instruction guide in a hard carry case
- 20" x 17" x 10"
- Three year warranty

#190338	1/each	\$860.00
---------	--------	-----------------

BLOOD PRESSURE

BTUSA BLOOD PRESSURE ASSESSMENT TRAINER

- Actual resistance feeling on the skin and venous wall
- Skin pad is composed of epidermis/ subcutaneous fat/vein
- User can select AC power or battery mode
- One-touch connection of the tube



#190631

1/each

\$3,000.00



COMMITTED TO PROVIDING QUALITY PRODUCTS



Geriatric™ & Keri™ Manikins

See page 82-83

Life/Form. DELUXE BLOOD PRESSURE SIMULATOR WITH SPEAKERS

- Allows the presetting of values for both systolic and diastolic pressures
- Three year warranty

#190329

Blood Pressure Simulator with Speaker

\$1,195.00

BLOOD PRESSURE TRAINING ARM

- Reproduces the five Korotkoff sounds and allows the instructor to vary systolic and diastolic levels, pulse rate, volume, and auscultatory gap
- For use with all Geriatric™ and Keri™ manikins

#190508

Blood Pressure Training Arm

\$995.00

Manikins

AIRWAY



Life/Form. PATIENT EDUCATION TRACHEOSTOMY CARE MANIKINS

- Features oral and nasal passages, the pharynx, epiglottis, trachea, esophagus, tracheostomy site, and cricoid cartilage
- Includes (1) tracheostomy tube, instruction guide and hard carry case, (1) adult manikin, (1) infant manikin
- Three year warranty

#190330	With Adult & Infant Manikins	\$860.00
#190331	With Adult Only	\$635.00
#190333	With Infant Only	\$289.00
#190332	Adult Trach Tube, 6CFS, 1/each	\$84.50



Life/Form. TRACHEOSTOMY CARE SIMULATOR

- Most realistic approximation of a patient available today
- Replicates an adult male containing oral and nasal passages and all appropriate anatomy - pharynx, epiglottis, trachea, esophagus, stoma, cricoid cartilage, and representative cervical vertebrae
- Includes instruction guide and hard carry case
- Three year warranty

#190334	1/each	\$605.00
---------	--------	-----------------



AIRWAY SUCTION TRAINER

- Life-size organs facilitate learning proper catheter insertion length
- Three catheter routes are prepared: oral, pharynx, and tracheostomy opening
- Includes head and neck model with airway anatomy, bottle of lubricant, two catheters, bottle of simulated sputum, metal tray, syringe, and storage case

#190335	1/each	\$1,600.00
---------	--------	-------------------



Life/Form. CHEST TUBE MANIKIN

- Includes (2) visual sites for chest tube maintenance, (5) replaceable surgical chest tube sites, (5) replaceable pneumothorax chest pads, and hard carry case
- Five year warranty

#190336	1/each	\$1,650.00
---------	--------	-------------------

CPR



BTUSA CPR SIMULATOR

- Displays ECG signal of stationary wave, ventricular fibrillation, V-tach, Poly-Ventricular Tachycardia, Mono-Ventricular Tachycardia 120bpm
- Evaluation is easier by applying wireless communication between simulator and laptop
- Save or print the information of practice and analyzed data
- Use either battery or AC power source

#190634 1/each **\$9,500.00**



CASPER THE CPR DOG

- Provides training in mouth-to-snout resuscitation with individual-use, disposable airway bags
- Disposable shield/lung bags eliminate cross contamination between students and the need to disinfect the manikin after every use
- Three year warranty

#190702 1/each **\$265.00**



CPR PROMPT® MANIKINS

- Easy to clean; replaceable lung bags
- Includes (10) face-shield lung bags and insertion tool and assembly instructions
- Three year warranty

#190101 Adult/Child Manikin **\$84.75**
 #190102 Infant Manikin **\$61.50**



\$ Great Value

FIVE MANIKIN EDUCATION PACKAGE

- Realistic anatomical markings; Adam's apple, carotid arteries, navel, rib cage, chest notch
- Includes rugged nylon carrying case, (50) face-shield lung bags and an insertion tool
- Three year warranty

#190103 Five Manikin Education Package **\$430.00**

Manikins

AUSCULTATION



- With SAM, students can easily and quickly compare one sound with another
- Innocent systolic murmurs often sound like the murmur of aortic stenosis if the patient has mitral valve prolapse with SAM, these and other sounds are presented along with a complete teaching guide
- Can be taught as a group using the optional simscope or classroom infrared emitter
- Practice on SAM using own stethoscope, and also with the optional SAM online

Features:

- (16) Heart/lung combination sounds
- (35) Heart sounds, (21) breath sounds, (20) bowel sounds, (4) carotid bruits sounds at correct anatomical site
- Heart sounds at 4 anatomical locations
- Breath sounds at 8 anatomical locations
- Bowel sounds at 2 anatomical locations
- Angle of Louis identified as landmark
- Anatomical t-shirt supplied with rib locations
- 200+ page lesson guide supplied

#190106	SAM II Light Skin	1/each	\$11,250.00
#190107	SAM Dark Skin	1/each	\$11,250.00
#190811	PAT Light Skin	1/each	\$11,250.00
#190812*	PAT Dark Skin	1/each	\$11,250.00
#190110	PAT Basic Light Skin	1/each	\$4,799.00
#190111*	PAT Basic Dark Skin	1/each	\$4,799.00
#190605*	Additional Sim Scope Stethoscope	1/each	\$1,990.00
#190606*	Simscope WiFi - Hybrid Simulator Complete	1/each	\$6,499.00
#190607	Additional Sim Scope WiFi Stethoscope	1/each	\$3,490.00

*Not shown

AUSCULTATION, DIALYSIS

Life/form. AUSCULTATION TRAINER AND SMARTSCOPE™ WITH SPEAKER SYSTEM

Features:

- Invisible auscultation sites
- No internal speakers
- Completely wireless
- Palpable landmarks
- Remote controlled
- Heart and lung sounds vary at different sites
- Includes manikin, (1) remote control with LCD display, (1) SmartScope™ with single- and dual-user headpieces, (1) 30-watt amplifier/speaker system with speaker and wire connections, and hard storage case
- Three year warranty



#190517	With Stereo System	\$3,075.00
#190518	Auscultation Trainer and SmartScope	\$2,890.00
#190218	Auscultation Practice Board	\$4,050.00



Life/form. PERITONEAL DIALYSIS SIMULATOR

- Designed to introduce patients, students, and nurses to the essentials of CAPD procedures and care
- Success with CAPD is dependent on the patient's following dialysis procedures with extreme care
- Includes indwelling Tenckhoff catheter in a hard carry case
- Three year warranty

#190340	Peritoneal Dialysis Simulator	\$610.00
---------	-------------------------------	-----------------



Life/form. HEMODIALYSIS PRACTICE ARM

- Easy to set up and use to demonstrate preparing the patient's arm for hemodialysis
- Designed with replaceable skin and vascular system
- Includes (1) pint Life/form® venous blood, (1) pint Life/form® arterial blood, (2) fluid supply bags, instruction booklet, and carry case
- Three year warranty

#190339	Hemodialysis Practice Arm	\$525.00
---------	---------------------------	-----------------

Manikins

SUTURE TRAINING



Life/Form. PEDIATRIC SUTURE HEAD UNIT

- Lifelike skin can be cut and sutured hundreds of times
- Completely washable and nontoxic
- Includes scalpel, forceps, needle holder and scissors in a soft case, one nylon suture, simulated blood, and baby powder
- Three year warranty

#190318 Pediatric Suture Head Unit **\$270.00**



Life/Form. FACIAL SUTURING MODULE SET

- Can be cut and stitched many times, then easily replaced over the permanent core and base
- Includes scalpel, forceps, needle holder and scissors in a soft case, baby powder, and one nylon suture
- Three year warranty

#190317 Facial Suturing Module Set **\$260.00**



Life/Form. SUTURE PRACTICE ARM

- Made with a soft vinyl skin over a core of stitchable foam
- Unit is provided with three "wounds"
- Three year warranty

#190320 Suture Practice Arm **\$170.00**



Life/Form. SUTURE PRACTICE LEG

- Made with a soft vinyl skin over a core of stitchable foam
- Unit is provided with three "wounds"
- Three year warranty

#190319 Suture Practice Leg **\$230.00**



Life/Form. SUTURE KIT

- Includes suture pad, tray to hold pad, carry case, needle holder, suture scissors, tissue forceps, scalpel, nylon suture, and small carry case
- Three year warranty

#190341 White 1/each **\$159.00**

#190342 Black 1/each **\$159.00**

WOUND CARE



Life/Form. ULTRA NURSING WOUND SIMULATION KIT

Includes:

- Simulated wounds
- Packaged in a hard carry case
- Ultimate kit designed to assist nursing educators in creating medical experiences that used to only be found in clinical settings
- Three-dimensional lifelike wounds can be cleaned, sutured and bandaged

#190345

Ultra Nursing Wound Simulation Kit

\$1,325.00



WE ADD THE PERSONAL TOUCH

Life/Form. SURGICAL SALLY

Features the following simulated wounds:

- | | | |
|--------------------------|---------------|----------------------------------|
| • Abdominal hysterectomy | • Colostomy | • Laparotomy |
| • Mastectomy | • Ileostomy | • Thyroidectomy |
| • Appendectomy | • Nephrectomy | • Leg amputation stump |
| • Cholecystectomy | • Laminectomy | • Sacral decubitus ulcer-stage 2 |
| • Mid-sternal split | • Thoracotomy | |

#190315

Surgical Sally

\$815.00



Manikins

WOUND CARE

Life/Form. BASIC NURSING WOUND SIMULATION KIT

Includes:

- Wounds
- Blisters
- Blood Blisters
- Boils
- Cysts: pilar and sebaceous
- Pressure ulcers, Stages 1-4
- Skin Cancer: normal, basal cell carcinoma, squamous cell carcinoma, and melanoma
- Venous Stasis Ulcers
- Ostomies: normal, double barrel, infected, prolapsed, and necrotic
- Makeup and Accessories
- Alcohol prep swabs
- Application sticks
- Blue makeup
- Brushes
- Clotted Red makeup
- Flesh modeling wax
- Foam wedges
- Gloves
- Glycerin
- Hard carry case
- Injury shades makeup
- Instruction booklets
- Red rubber round scissors
- Special effects makeup
- Spirit gum



- Spirit gum remover
- Spray bottle (empty)
- Stipple sponges
- Wet Wipes
- White towel

#190216

Basic Nursing Wound Simulation Kit

\$665.00

Life/Form. ADVANCED NURSING WOUND SIMULATION KIT

Includes:

- Wounds
- Abrasion
- Burn, 1st degree
- Burn, 2nd degree, deep partial thickness
- Burn, 3rd degree
- Chicken Pox
- Cyst: infected
- Dehiscence
- Incisions: normal and infected
- Lacerations: superficial and deep
- Lyme disease
- Shingles
- Makeup and accessories
- Alcohol prep swabs
- Application sticks
- Ash dust powder
- Black soot powder
- Blood blister makeup
- Blood colored modeling wax
- Brushes
- Clotted Red makeup
- Dirt powder
- Foam wedges
- Gloves
- Glycerin
- Hard carry case
- Injury shades makeup
- Instruction booklets
- Light cream makeup
- Liquid latex
- Magic blood powder



#190217

Advanced Nursing Wound Simulation Kit

\$765.00

EDEMA



Life/Form. NON-PITTING EDEMA TRAINER

Includes

- (2) tissue pads representing a non-pitting stage and a pitting stage
- Insert tray
- Key card with cleaning/care instructions
- Storage box

#190343 Non-Pitting Edema Trainer **\$55.00**

Life/Form. PITTING EDEMA TRAINER

- Ultimate kit designed to assist nursing educators in creating medical experiences that used to only be found in clinical settings
- Three-dimensional lifelike wounds can be cleaned, sutured, and bandaged
- Included are simulated wounds, makeup, and makeup accessories all packaged in a hard carry case

#190344 Pitting Edema Trainer **\$106.00**



**GERi™ or KERi™
Manikins**
See page XX

See New Products

See pages 128–133



Life/Form. GERI & KERI OPTIONAL EDEMA FOOT WITH DEEP TISSUE INJURY

- Includes a foot that easily attaches to any GERi™ or KERi™ patient care
- Manikin, (5) interchangeable pads representing one non-pitting stage and four pitting stages of edema, and an instruction key card
- Three year warranty

#190324 Edema Trainer **\$190.00**

Life/Form. NEGATIVE PRESSURE WOUND THERAPY TRAINER

- For demonstration of application, placement, and management of a negative-pressure wound therapy system
- 8-1/2" L x 8-1/2" W x 2" D
- 7" L x 7" W x 1" D
- 9" L x 9" W x 2-1/2" D
- Three year warranty

#190326 Wound Therapy Trainer **\$260.00**

Manikins

ULCER, BURNS

Life/Form BURN SIMULATION KIT

- Blisters
- Burn, 1st degree
- Burn, 2nd degree, superficial partial
- Thickness
- Blood blisters
- Burn, 2nd degree, deep partial
- Thickness
- Burn, 3rd degree
- Makeup and accessories:
 - Alcohol prep swabs
 - Ash dust powder
 - Black soot powder
 - Blood blister makeup
- Blood paste
- Brushes
- Clotted red makeup
- Dirt powder
- Foam wedges
- Gloves
- Glycerin
- Hard carry case
- Injury shades makeup wheel
- Instruction booklets
- Light cream makeup
- Magic blood powder
- Red rubber round



- Spirit gum remover
- Spirit gum with brush
- Spray bottle (empty)
- Stipple sponges
- Wet wipes

#190351	Burn Simulation Kit	\$375.00
---------	---------------------	-----------------



Life/Form ELDERLY PRESSURE ULCER FOOT

- For instruction on care and cleaning of pressure ulcers in various stages
- Includes a foot and instruction key card
- 9-1/2" x 4"
- Three year warranty

#190325	Ulcer Foot	\$115.00
---------	------------	-----------------



Life/Form PRESSURE ULCER MODELS

- Models illustrate all four wound stages and are used to give instruction on the care and cleaning of the ulcers
- Includes (4) buttocks models representing each stage, (4) display easels, and instruction key card
- 6-1/2" x 6-1/4" x 1"
- Three year warranty

#190321	Pressure Ulcer Models	\$365.00
---------	-----------------------	-----------------

STUMP BANDAGING

Life/Form. STUMP BANDAGING TORSO

Includes:

- (2) Arms; one is amputated above the elbow; the other above the wrist
- Practice and demonstrate standard bandaging procedures
- 26" x 18" x 13"
- Three year warranty

NOTE: There is no embedded, palpable skeletal material



#190313	Stump Bandaging Torso	\$258.00
---------	-----------------------	-----------------

Need a Special Manikin?

Call 855-MED-SHIP



Life/Form. LOWER STUMP BANDAGING SIMULATOR

- Practice and demonstrate standard bandaging procedures
- Lower torso is long enough to allow carrying the bandage around the body over the uninvolvd hip at the level of the iliac crest
- 35" x 15" x 10"
- Three year warranty

NOTE: There is no embedded, palpable skeletal material

#190322	Lower Stump Bandaging Simulator	\$258.00
---------	---------------------------------	-----------------



Life/Form. STUMP BANDAGING SIMULATORS (Set of 2)

- Practice and demonstrate standard bandaging procedures
- Lower torso is long enough to allow carrying the bandage around the body over the uninvolvd hip at the level of the iliac crest
- Upper stump: 26" x 18" x 13", lower stump 35" x 15" x 10"
- Three year warranty

NOTE: There is no embedded, palpable skeletal material

#190323	Stump Bandaging Simulators	\$450.00
---------	----------------------------	-----------------

Manikins

OSTOMY



Life/form. OSTOMY CARE TRAINING 5-MODEL SET

- Includes all Ostomy Care Training Models:
 - (1) Nonfunctioning double barrel ostomy care training model
 - (1) Nonfunctioning prolapsed ostomy care training model
 - (1) Functioning healthy ostomy care training model
 - (1) Functioning infected ostomy care training model
 - (1) Functioning necrotic ostomy care training model
- Three year warranty

#190327

Ostomy Care Training 5-Model Set

\$440.00



OSTOMY CARE MODEL

- Made of BIOLIKE2™ tissue, feels like real flesh
- May be washed with soap and water, taped, bandaged, or fitted with ostomy bags
- All four stomas may be lubricated and dilated with an inserted finger
- Includes lubricant, draping sheet, and carrying case.
- 13" x 18" x 3"

#190312

Ostomy Care Model

\$346.15



Life/form. RETRACTED OSTOMY CARE TRAINING MODEL

- For demonstration and practice of ostomy care procedures on a stoma that has sunken below skin level, including cleaning and changing the pouching system
- Includes model, display easel, syringe, simulated stool, lubricant, and instruction manual
- 7" L x 7" W x 3" D
- Three year warranty

#190328

Ostomy Care Trainer

\$99.75



SIM FLAT BELLY

- Provides the option to use your birthing manikin as a non-birthing female patient
- Attaches with hook and loop tape or snaps to the existing sites on the manikin

#190906 1/each **\$174.00**



SIM LEGGINGS, EXTENDERS

- Available to accommodate the calf sizes of larger standardized patients
- Zip into the back of the SimLegging

#190909 1/each **\$59.99**

Use with manikins or "live" models



SIM SLEEVES

- Simulate the look and feel of lymphedema
- Two colors: Beige & Dark Brown
- Two sizes: small & large

#190901 Large 1/each **\$374.00**



SIM LEGGINGS

- Simulation accessories that are designed to zip over the ankles and lower legs of manikins
- Attaches with hook and loop tape or snaps to the existing sites on the manikin

#190902 Large 1/each **\$374.00**

#190903 Small 1/each **\$174.00**



SIM OBESITY SUIT JR

- One-piece "jumpsuit" that zips up the back
- Bilateral injection sites
- Allows access to the perineum
- Machine wash and dry the outer skin
- Available in beige and dark brown
- Includes a storage bag

#190907 1/each **\$694.00**



SIM OBESITY SHIRT

- Weighted pendulous breasts and pannus create deep skin folds that highlight the need for thorough assessment of the bariatric patient
- Includes all padding and weights to give you this realistic look and storage bag

#190908 1/each **\$849.00**

Carts

Defibrillators
ECGs

Diagnostics

Gloves

Hospital
Beds

Infusion

Labels

Manikins
Simulators

Media

Monitors

New
Products

Patient
Care

Patient
Room

Practice
Meds

PYXIS®

Respiratory

Student
Kits

Syringes

Training
Headwall
Unit

MEDIA HEALTH

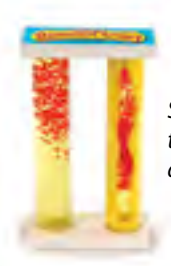

Shows blood flow through a healthy and a clotted artery



DELUXE OCCLUDED ARTERY MODEL

- Change the way people think about cardiovascular health
- Magnifies the difference between a healthy artery and one that is clogged
- Flip the display over and watch as blood cells travel through the clean artery versus through a jagged maze of cholesterol buildup
- Captures the exact moment a heart attack occurs
- 7" x 12" x 3"

#260101	Deluxe Occluded Artery Model	1/each	\$139.00
---------	------------------------------	--------	-----------------

CLOGGED ARTERY MODEL

- Filled with pasty yellow gunk-simulated plaque buildup
- 1-1/2" x 3"

#260107	Clogged Artery Model	1/each	\$69.00
---------	----------------------	--------	----------------

HIGH BLOOD PRESSURE FLIP CHART

- Flip chart gives real-life strategies for controlling high blood pressure
- Flip chart is 6 panels, features presentation notes on reverse panels
- 12" x 17"

#260109	High Blood Pressure Flip Chart	1/each	\$89.00
---------	--------------------------------	--------	----------------

HEART DISEASE RISK FACTORS DISPLAY

- Interactive display
- Educational activity to calculate heart disease risk factors
- Tallies both controllable and noncontrollable risk factors
- 20-1/2" x 28"

#260110	Heart Disease Risk Factors Display	1/each	\$99.00
---------	------------------------------------	--------	----------------

COLORECTAL POLYP MODEL

- Includes (5) polyps and (1) invasive cancer
- Use to explain screening and colon cancer
- 3-1/2" long

#260638	Colorectal Polyp Model	1/each	\$99.00
---------	------------------------	--------	----------------

HEALTH

THE BASICS OF CHOLESTEROL DISPLAY

- Features gut-churning color photos of cholesterol's damaging effects
- Explains what cholesterol is, factors that influence cholesterol levels, differences between "good" & "bad" cholesterol testing, and how to maintain healthy levels
- 43-1/2" x 22-1/2" opened

#260111 The Basics Of Cholesterol Display 1/each **\$79.00**

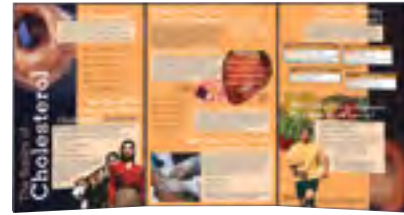

PREVENTING OSTEOPOROSIS DISPLAY

- Motivate your audience to keep their bones healthy
- Explains what osteoporosis is and what it looks like
- 58" x 22-1/2" opened

#260205 Preventing Osteoporosis Display 1/each **\$99.00**



SEVERE DIABETIC FOOT MODEL

- Depicts an amputated toe swelling and redness from severe infection
- Includes a carrying case
- 3-1/2" x 9-1/2" x 4"

#260640 Severe Diabetic Foot Model 1/each **\$129.00**



THE CONSEQUENCES OF DIABETES 3D DISPLAY

- Arresting models depicting a heart attack, a stroke, and infected gums
- Display is contained within its own carrying case
- 28" x 27" opened

#260628 The Consequences Of Diabetes 3D Display 1/each **\$345.00**



CHILDHOOD IMMUNIZATION FOLDING DISPLAY

- Discusses what childhood vaccinations are and why they are needed
- Covers 15 diseases that can be vaccinated against
- 58" x 22" opened

#260639 Childhood Immunization Folding Display 1/each **\$119.00**



MEDIA

WOMEN/MEN'S HEALTH



Most Popular!



INTERACTIVE MULTI-TYPE BSE MODEL (Beige)

- Features (3) BIOLIKE 2™ models of normal tissue
- Includes carrying case
- 13-1/2" x 11-1/2" x 14-1/2"

#260201	Interactive Multi-Type BSE Model	1/each	\$259.00
---------	----------------------------------	--------	-----------------

STANDARD BSE MODEL (Beige)

- Soft BIOLIKE 2™ model mimics the feel of real tissue
- Palpable lumps teach how to locate potential abnormalities
- Non-palpable lumps only visible with a penlight

#260202	Standard BSE Model	1/each	\$99.00
---------	--------------------	--------	----------------

TEEN BSE/TSE MODEL KIT

- Two (2) BIOLIKE 2™ models instill a lifelong sense of health self-awareness
- Includes (1) Teen BSE Model containing various-sized lumps and (1) TSE Model which has two lumps in each testicle

#260641	Teen BSE/TSE Model Kit	1/each	\$219.00
---------	------------------------	--------	-----------------

FACTS ABOUT TESTICULAR AND PROSTATE CANCER FOLDING DISPLAY

- Emphasizes the importance of testicular self-examination & prostate screening
- Identifies the risk factors symptoms and treatment of each condition
- 58" x 22-1/2" opened

#260642	Testicular & Prostate Cancer Display	1/each	\$119.00
---------	--------------------------------------	--------	-----------------

WHY PAP TESTS CAN SAVE YOUR LIFE EASEL DISPLAY

- Promotes the importance of Pap tests with hand-painted cervix models
- Depicts a normal cervix, a cervix with a benign tumor, and cervixes with cancer
- 9" x 12"

#260211	PAP Tests Display	1/each	\$109.00
---------	-------------------	--------	-----------------

PREGNANCY/CHILDCARE

GUIDE TO CONTRACEPTIVES KIT

- Kit uses 3D models to present a wide variety of contraceptive methods
- Includes (2) stand-alone panels and informative handout
- Case has a Plexiglas cover
- 29" x 20" opened



#260643	Guide To Contraceptives Kit	1/each	\$339.00
---------	-----------------------------	--------	-----------------

CONSEQUENCES OF STDS DISPLAY

- Shows the far-reaching consequences of unprotected sex
- Display comes in self-contained carrying case
- 28" x 27" opened



#260647	STDS Display	1/each	\$399.00
---------	--------------	--------	-----------------

CONDOM TRAINING MODEL (Economy)

- Model "ejaculates" UV light-sensitive fluid to demonstrate the importance of correct condom use
- Includes syringe, UV light-sensitive fluid, and six condoms
- 2-1/2" x 5-1/2" x 2-1/2"



#260644	Condom Training Model	1/each	\$119.00
---------	-----------------------	--------	-----------------

"READY-OR-NOT TOT" (Enhanced Version)

- Model requires attention more than 20 times
- Offers (3) 48-hour program settings
- Standard version comes with student keys, teacher keys, parental consent form, student response sheet, and teacher correction template
- Enhanced also includes bendable neck, drug-affected settings, and more
- 5-1/2lb; 20" long



#260645	Standard	White Male	1/each	\$475.00
#260646	Enhanced	White Female	1/each	\$599.00

MEDIA

PREGNANCY/CHILDCARE



CHILDBIRTH MODEL SET

- Includes a 19" cloth Fetal Model, Pelvis Model, Perineal Cloth Model, Placenta/Cord/Amnion/Chorion
- Each model also sold separately

#260648	Childbirth Model Set	1/each	\$239.00
---------	----------------------	--------	-----------------



FETAL MONITORING AND LABOR PROGRESS MODEL

- Includes a fetal head, lower uterine segment, fetal buttocks for breech presentation, (4) interchangeable cervical dilatation models, durable case, lubricant and teaching suggestions
- 5-1/2" x 5" x 8-1/2"

#260633	Fetal Monitoring And Labor Progress Model	1/each	\$550.00
---------	---	--------	-----------------



FETUS MODEL SET (4)

- Realistic BIOLIKE 2™ fetus models depict the womb at 12, 16, 22, and 30 weeks
- Includes (4) models and carrying case

#260634	Fetus Model Set	1/each	\$239.00
---------	-----------------	--------	-----------------



UTERUS/FETUS MODEL SET (5)

- Illustrates fetal development at 8, 10, 16, 22, and 40 weeks
- Forty week uterus model can demonstrate different fetal positions
- Includes (5) uterus/fetus models and carrying bag

#260621	Uterus/Fetus Model Set	1/each	\$429.00
---------	------------------------	--------	-----------------

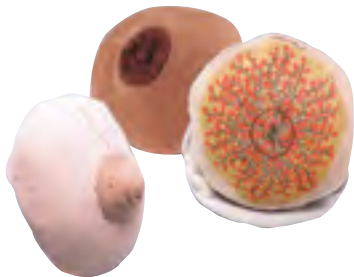

CLOTH BREAST MODEL (Beige)

- Model demonstrates breast-feeding techniques
- Simulates a plugged duct and a breast lump
- Includes teaching ideas and instructions
- 5-1/2" diameter

#260630	Cloth Breast Model	1/each	\$119.00
---------	--------------------	--------	-----------------

PREGNANCY/CHILDCARE

NEW WITH CHILD™ SIMULATOR

Physical discomforts of pregnancy are experienced first hand include:

- Weight gain of approx. 25 lb
- Abdominal distention
- Pelvic tilt
- Waddling gait
- Abdominal aches
- Lower back stress
- Inability to get comfortable
- Pressure on bladder, stomach, & lungs
- Shortness of breath
- Difficulty rising from chair or bed
- Increased breast size
- Rise in body temperature
- Increased blood pressure & pulse
- Fetal movement
- Limited breathing
- Decreased mobility
- Tiredness

Includes:

- (1) Pregnancy simulation torso
- (1) Tunic (to wear over simulation torso)
- (1) Timeline of pregnancy chart
- (50) Comfort measures in pregnancy booklets
- (1) Presentation guide
- (1) Wheeled carrying case



#260649	Child Pregnancy Simulator	1/each	\$799.00
---------	---------------------------	--------	-----------------

WHAT MOMMY DOES, BABY DOES MODEL

- 3D model illustrates how alcohol, tobacco, and other substances can cross the placenta and damage a fetus
- Cigarette butts, pills, and beer bottle caps suspended in plastic
- Excellent for health educators and healthcare professionals
- Use in education or on display
- 5" x 6" x 1-1/2"

#260311	What Mommy Does, Baby Does Model	1/each	\$65.00
---------	----------------------------------	--------	----------------



HAZARDS DURING PREGNANCY DISPLAY

- Critical information about things that can be harmful to babies and moms
- Covers diseases and infections, chemicals, alcohol, tobacco, drugs, and more
- 58" x 22-1/2" opened

#260310	Hazards During Pregnancy Display	1/each	\$99.00
---------	----------------------------------	--------	----------------



MEDIA

TOBACCO



A YEAR'S WORTH OF TAR MODEL

- Tar is sealed in an easy-to-handle, shatterproof container
- Represents the amount of tar in lungs of a half-pack-a-day smoker in 1 year
- 3-1/2" x 5-1/2" x 3-1/2"

#260301	A Year's Worth Of Tar Model	1/each	\$69.00
---------	-----------------------------	--------	----------------

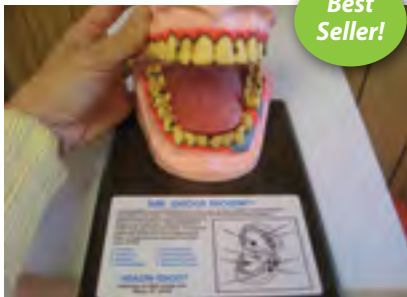

MR. GROSS MOUTH MODEL

- Features detail of the disgusting oral damage done by smokeless tobacco
- Realistic, hand-painted, hinged model comes mounted on a wooden display base and includes a jar of tobacco
- 6" x 4" x 8"; carrying case is available

#260302	A Year's Worth Of Tar Model	1/each	\$399.00
---------	-----------------------------	--------	-----------------



MR. DIP LIP (*Interactive*)

- BIOLIKE 2™ model opens and closes from the back and the lips retract to show the damage done to the inner lips gums and teeth by tobacco
- 6" x 5" x 6"

#260303	Mr. Gross Mouth Model	1/each	\$150.00
---------	-----------------------	--------	-----------------



THE CONSEQUENCES OF SMOKING 3D DISPLAY

- Includes (8) graphic models which feature emphysematous and cancerous lungs, a premature baby, and a stroke-affected brain
- Comes in self-contained carrying case
- 28" x 27" opened

#260304	The Consequences Of Smoking 3D Display	1/each	\$499.00
---------	--	--------	-----------------

TOBACCO

EFFECTS & HAZARDS OF SECONDHAND SMOKE DISPLAY

- Folding display gives the basic facts about secondhand smoke and its dangers
- Outlines ways to protect family members from secondhand smoke
- 58" x 22-1/2" opened

#260305 Effects of Secondhand Smoke Display 1/each **\$99.00**



A CLOSER LOOK AT TOBACCO 3D DISPLAY

- Ultra-realistic facsimiles of every type of tobacco product, enclosed in Plexiglas
- Reflects recent changes in tobacco laws
- 32" x 24"

#260306 A Closer Look At Tobacco 3D Display 1/each **\$450.00**



TOBACCO INGREDIENTS DISPLAY

- Includes a two-sided tent card that explains each of the models in the display and the harmful chemical represented
- Display is 24-1/2" x 3-1/2"

#260308 Tobacco Ingredients Display 1/each **\$129.00**



LOU-WHEEZE SMOKER'S LUNGS COMPARISON MODEL

- One of Lou-Wheeze's lungs is smooth and pink and the other one is destroyed by emphysema
- Carrying case available separately
- 17" x 23-1/2"

#260626 Smoker's Lungs Comparison Model 1/each **\$275.00**



MEDIA

TOBACCO/ALCOHOL



COUGH UP A LUNG MODEL

- Life-size model can be opened to reveal that this is a terminal case
- Tumors crowd around the bronchus, the lung tissue is riddled with air pockets, and the bronchial tube is plugged with slimy green phlegm
- 5-1/2" x 8-1/2" x 5"

#260650	Cough Up A Lung Model	1/each	\$179.00
---------	-----------------------	--------	-----------------



CAUSE OF DEATH: SECOND HAND SMOKE DISPLAY

- Surprising "post-mortem" lung model shows that secondhand smoke can be an indiscriminate killer
- 5" x 7"

#260651	Second Hand Smoke Display	1/each	\$139.00
---------	---------------------------	--------	-----------------



Recreates the visual distortion of alcohol.

D.W. EYES GOGGLES AND GLASSES

- Specially designed eyewear recreates the visual distortion, loss of perception and lack of control that impair drunk drivers
- They do not represent a specific blood alcohol concentration

#260501	Goggles	1/each	\$149.00
#260652	Glasses	1/each	\$179.00



THE CONSEQUENCES OF ALCOHOL ABUSE 3D DISPLAY

- Graphically depicts alcohol abuse's destructive trail of internal damage
- Display is contained in sturdy carrying case
- 28" x 27" opened

#260505	Consequences Of Alcohol Abuse 3D Display	1/each	\$349.00
---------	--	--------	-----------------

ALCOHOL/DRUGS

BINGE DRINKING FOLDING DISPLAY

- Highlights alcohol poisoning, effects of binge drinking, and how to get help for a drinking problem
- 58" x 22" opened



#260653 Binge Drinking Folding Display 1/each **\$109.00**

SEX UNDER THE INFLUENCE AWARENESS KIT

- Economy Condom Training Model (including syringe, UV light-sensitive fluid, and condoms) quickly reveals that sex and alcohol can be a volatile mix
- Includes detailed activity guide and carrying case



#260654 Sex Under The Influence Awareness Kit 1/each **\$275.00**

DRUG IDENTIFICATION GUIDE

- Features realistic 3D facsimiles enclosed behind Plexiglas
- Display stands on any tabletop and includes reproducible handout
- 32" x 24"



#260401 Drug Identification Guide 1/each **\$399.00**

THE CONSEQUENCES OF DRUG ABUSE 3D DISPLAY

- (8) organ models which includes a reproduction of a drug-affected baby's brain
- Models are accompanied by brief descriptions of each condition
- 28" x 27" opened and comes in its own carrying case



#260402 Consequences Of Drug Abuse 3D Display 1/each **\$349.00**

MEDIA

DRUGS/NUTRITION



MARIJUANA FLIP CHART

- Information on the appearance, side effects, and physical consequences of marijuana
- Six-panel flip chart has presentation notes on back of each panel
- 12" x 17"

#260406	Marijuana Flip Chart	1/each	\$89.00
---------	----------------------	--------	----------------



DRUGGED AND DISTORTED GAME

- Game requires participants to wear goggles and motion-restriction hand, while doing ordinary activities such as handling money, typing, and doing a series of normal office tasks

#260655	Drugged And Distorted Game	1/each	\$335.00
---------	----------------------------	--------	-----------------



RETHINK YOUR DRINK

- Chart is resistant to soda, juice and other sweetened beverages that viewers may spray on it when they see the sugar content of their favorite drink
- Featuring ten popular beverages
- 18" x 24"

#260602	Rethink Your Drink	1/each	\$19.00
---------	--------------------	--------	----------------



ENERGY CRISIS DISPLAY

- Wake people up to the dangers of energy drink
- Modeled after five popular energy drinks

#260603	Energy Crisis Display	1/each	\$99.00
---------	-----------------------	--------	----------------

NUTRITION

FAT CHUNKS AND MIGHTY MUSCLES SET

- Sleek-shaped muscles quickly remind everyone that their “chunky” counterparts take up twice the space even though they weigh the same
- Set comes with tent cards and carrying cases



#260604	Fat Chunks And Mighty Muscles Set	1/each	\$275.00
---------	-----------------------------------	--------	-----------------

JUNK FOR SALE DISPLAY

- Looks like a snack machine
- Labels emphasize the sugar, saturated fat, sodium, and calories
- 24" x 32"



#260606	Junk For Sale Display	1/each	\$350.00
---------	-----------------------	--------	-----------------

FAT CLOSER LOOK AT FAST FOOD DISPLAY

- Includes (10) tempting food models and corresponding fat-filled test tubes
- Includes (10) food cards with nutritional information
- Carrying case and reproducible handout



#260613	Fast Food Display	1/each	\$225.00
---------	-------------------	--------	-----------------

WHAT YOU SHOULD KNOW ABOUT NUTRITION

- Three day seminar information condensed into (4) colorful panels
- Features important food group points and dietary guidelines about fruits, vegetables, grains, dairy, and protein foods
- 58" x 22-1/2" opened



#260627	Nutrition Display	1/each	\$119.00
---------	-------------------	--------	-----------------

MEDIA

NUTRITION



CONSEQUENCES OF OBESITY 3D DISPLAY

- Carrying extra weight has a taxing effect on every cell in the body
- Includes carrying case
- 28" x 27" opened

#260656	Consequences Of Obesity 3D Display	1/each	\$425.00
---------	------------------------------------	--------	-----------------



FAUX FOODS STARTER PACKAGE

Contains (40) realistic food models selected from our individual faux foods collection

Foods included in the Starter Package

Apple juice (6 oz)	Crackers (6 salted)	Hamburger (3oz cooked)
Banana (whole without skin)	Dry cereal (3/4cup)	All beef hot dog (1-1/2oz)
Green grapes (15in bowl)	Hamburger bun (halves)	Kidney beans (1/2cup)
Orange juice (6oz)	Oatmeal (1/2cup in bowl)	Peanut butter (1tbsp)
Pears (2 halves, canned)	Popcorn (1cup)	Macaroni and cheese (1/2cup)
Strawberries (6 whole)	Spaghetti noodles (1/2cup cooked)	Tossed salad (1cup in bowl)
Baby carrots (1cup)	White bread slice	French dressing (1tbsp)
Baked potato	White rice (1/2cup)	Margarine (1tbsp)
Broccoli (1/2cup)	Wheat bread slice	Mayonnaise (1tsp)
Corn (1/2cup)	American cheese (1 slice)	Candy bar
Green beans (1/2cup)	Fat-free milk (8oz)	Chocolate chip cookie (2)
Spinach (1/2cup)	Plain yogurt (1cup)	Vanilla ice cream (1/2cup)
Bagel (3oz)	Swiss cheese slice (1oz)	
Corn tortilla (6" diameter)	Chicken breast (3oz fried)	

#260612	Faux Foods Starter Package	1/each	\$299.00
---------	----------------------------	--------	-----------------

NUTRITION

DIABETES NUTRITION TEACHING KIT

- Teaching kit explains the different types of diabetes
- Thirty-page resource book defines diabetes mellitus and provides menu guides, exercise suggestions, and seven blackline masters
- Includes (11) food replicas and resealable bags for storage



#190512 Diabetes Nutrition Teaching Kit 1/each **\$89.00**

VARIETY FOOD ASSORTMENT KIT

Replicas include:

Apple	Chicken Leg	Peach
Banana, Half	Corn	Pear
Banana, Whole	Corn On The Cob	Peas
Beans, Green	Egg, Fried	Potato, Baked
Beets	Hamburger Bun	Strawberries
Bread, White	Hamburger, Fried	Tomato
Candy Bar	Milk, Whole	Wiener
Carrots	Orange	Yam



#190513 Variety Food Assortment Kit 1/each **\$189.00**

BASIC DAIRY KIT

Replicas include:

Lowfat Chocolate Milk (8oz)	Skim Milk (8oz)
Cheese Cubes (3oz)	Whole Milk (4oz)
Cottage Cheese (1/4cup)	Yogurt (8oz)

#190514 Basic Dairy Kit 1/each **\$49.00**



BASIC PROTEIN KIT

Replicas include:

Baked beans	Pork tenderloin
Beef cubes	Peanut butter dab
Chicken breast, fried	Tilapia
Egg, fried	

#190515 Basic Protein Kit 1/each **\$55.00**



BASIC FRUIT KIT

Replicas include:

Apple	Plums
Banana	Pear
Orange, Peeled	Strawberries

#190516 Basic Fruit Kit 1/each **\$69.00**



MONITORS

VITAL SIGNS MONITORS



#210203

Welch Allyn SPOT VITAL SIGNS® DEVICES

- Lightweight and portable
- Measures noninvasive blood pressure (NIBP), pulse rate, temperature and SpO₂
- Provides IR Connectivity to electronic medical records
- Choice of mounting options; all configurations include NIBP, pulse rate and MAP

#210201	NIBP Only	\$1,099.00
#210204	NIBP/Temperature	\$1,495.00
#210202	NIBP/Nellcor Pulse Oximeter	\$2,150.00
#210203	NIBP/Nellcor Pulse Oximeter/Temperature	\$2,495.00



#210206

#210205

Welch Allyn SPOT WALL MOUNT

- Wall mount fits the Spot and Spot LXi Vital Signs monitors

#210205	Wall Mount	\$250.00
---------	------------	-----------------

Welch Allyn MOBILE SPOT MONITOR STAND

- Mobile stand with basket for Vital Signs monitor

#210206	Mobile Spot Monitor Stand	\$350.00
---------	---------------------------	-----------------



#210401

COMPLETE VITAL SIGNS MONITORS

Includes:

- 5.7" High resolution display
- Simultaneous numeric and waveform information display
- Nurse call
- Built-in, 8-hour lithium-ion battery
- PR measurement (SpO₂/ NIBP)
- Trend table/graph review and record
- USB data storage and review, with wired/wireless network capability
- Three year warranty

#210402	Adult Reusable SpO ₂ Sensor, Adult Cuff, and NIBP Tube with Connector	\$1,450.00
#210401	Adult Reusable SpO ₂ Sensor, Adult Cuff, NIBP Tube with Connector, and Infrared Ear Temperature Kit	\$1,750.00

VITAL SIGNS MONITORS

STANDARD VITAL SIGNS® MONITORS

- 3.5" Color TFT LCD and clear LED numeric indication display
- 21 Hour longer-life battery
- Spot-check and continual working modes with alarm
- High capability data storage
- Backlight control and power-saving standby mode
- PatientCare Viewer smart data management software
- Nurse call
- Easy mounting



#210406

#210403	Adult Reusable SpO ₂ Sensor Three-Year Warranty	\$999.00
#210404	NIBP Tube with Connector only	\$999.00
#210405	Adult Reusable SpO ₂ Sensor, Adult Cuff, and NIBP Tube with Connector	\$1,199.00
#210406	Adult Reusable SpO ₂ Sensor, Adult Cuff, NIBP Tube with Connector and Infrared Ear Temperature Kit	\$1,595.00

IM50 PATIENT MONITOR

- 8.4" Color TFT LCD monitor
- 3/5 ECG, RESP, NIBP, Edan SpO₂, 2-TEMP, PR
- (1) Skin temperature probe
- Adult cuff (25cm–35cm)
- NIBP tube (3m) with connector
- (1) EDAN SH1 adult reusable SpO₂ sensor
- (1) 3-lead ECG integrative cable with leadwires, snap (AHA) (defibrillation)
- (30) Adult disposable adhesive electrodes (nonwovens), snap (30pcs/pack)
- (1) Rechargeable lithium-ion battery (14.8V, 4200mAh)
- (1) User manual, (1) power cord, and (1) ground cable



#210314	IM50 Patient Monitor	\$2,250.00
---------	----------------------	-------------------

Welch Allyn CONNEX® 6300 VITAL SIGNS MONITORS

- Color touchscreen
- Measures BP as cuff is inflating
- BP averaging
- Supports adult, pediatric and neonatal monitoring
- Includes pulse rate and MAP



#210309	Blood Pressure, Temp (SureTemp Plus)	\$2,899.00
#210310	Blood Pressure, SpO ₂ (Nelcor)	\$3,250.00
#210311	Blood Pressure, SpO ₂ (Nelcor)Temp (SureTemp Plus)	\$3,699.00
#210312	Blood Pressure, SpO ₂ (Nelcor), Temp (SureTemp Plus) and Printer	\$4,250.00
#210313	Welch Allyn Convex Stand	\$399.00



Medical Shipment is the **Exclusive Accuvein Distributor** for all educational institutions across the country



#120352

VEIN VIEWING SYSTEM

The AccuVein AV400 digitally displays a map of the vasculature on the surface of the skin in real time, allowing clinicians to verify vein patency and avoid valves or bifurcations.



- Handheld and lightweight
- Weighs only 9.7 ounces
- Easily converts to hands free with the use of optional wheeled or fixed stands



- Medical grade design allows the device to be easily wiped clean
- Bagged for use in isolation
- Permanently aligned

ACCUVEIN AV400 WHEELED STAND

The HF470 wheeled stand is the latest in AccuVein's family of hands-free accessories and it is ideal for any medical setting in which vein illumination needs to be brought to the patient.

- Charges while it is in the secure "quick cup" of the HF470 stand
- "Quick cup" allows the AV400 to be easily placed in the stand



- Can be precisely positioned to keep the selected vein highlighted
- Patient can be easily accessed with the arm's extended and flexible reach



#120353

#120352	AV400 Viewing System	1/each	\$5,500.00
#120353	HF470 Wheeled Stand	1/each	\$699.00

New Products



MODULAR DIAGNOSTIC STATIONS

Features include:

- Ergonomic handle with automatic ON/OFF function
- Space saving with smallest equipment footprint available
- Equipment is treated with Microbecare antimicrobial to assist with infection control
- Expands to over 10'
- Easy to clean and disinfect



- Standard anti-theft locking instrument heads
- Multiple mounting possibilities to suit specific needs

#220112	Modular Diagnostic Stations	\$999.00
---------	-----------------------------	----------

5-FUNCTION TRAINING BED

- (3) Amico Ohmeda gas outlets - OAV
- (1) Amico DISS compressed air outlet
- (1) Duplex receptacle
- (1) Vacuum slide
- (1) Nurse call 3-gang cover
- (1) Mounting strip

#140314	5-Function Training Bed	1/each	\$7,999.00
---------	-------------------------	--------	------------



See more Diagnostic Station options

See pages 24–49

MULTI-TREATMENT HYDRAULIC STRETCHER

- Centrally controlled brake system
- Collapsible side rails
- dual side foot pedals
- Retractable 5th wheel steering system
- X-ray compatible backrest
- Shock absorbing, non-marking bumpers

#140406	Multi-Treatment Hydraulic Stretcher	1/each	\$3,199.00
---------	-------------------------------------	--------	------------



NEW PRODUCTS

METRO ACCESS POINT, POINT OF CARE COMPUTER/MEDICATION CART

- Battery-only replacement
- Fully-adjustable display mount
- Electronic lift
- Standard keypad controller
- Compact footprint



#220112	2 Tier Cart	\$7,790.00
#220111	3 Tier Cart	\$7,990.00
#220110	4 Tier Cart	\$8,190.00

METRO METRO MAX Q POLYMER AND STEEL SHELVING

- Built of advanced polymers with type 304 stainless steel corners
- Microban® Antimicrobial Product Protection
- Easy to clean
- Lifetime warranty against rust and corrosion

#220644	Metro Max Q Polimer and Steel Shelving	1/each	1,650.00
---------	--	--------	-----------------



Cardionics AUSCULTATION MANIKIN

A comprehensive approach to teaching and learning critical auscultation and clinical skills. Utilizing the full product line of supportive tools, provides fun and easy interaction while teaching and learning critical skills.

Pat

- (23) Different heart sounds at different rate , (4) heart lung sounds/palpation, (15) pediatric breath sounds & (3) pediatric bowel sounds
- Lightweight and portable
- Allows students the opportunity to practice with their own stethoscope



SAM II

Sam II

- Portable
- Contains all generally recognized pediatric sounds
- (35) Heart, (21) breath, (16) bowel, and (4) carotid bruit sounds

#190811	"Pat" Pediatric (<i>Light Skin</i>)	1/each	\$11,250.00
#190106	"Sam II" Student (<i>Light Skin</i>)	1/each	\$11,250.00

New Products

BT TECHNOLOGY

CPR SIMULATOR

- Evaluation of users check on responsiveness, pulse, and opening of the airway
- Pupillary reflex, pulse beating, and spontaneous breathing
- Depth and position of compression are displayed in real time
- Simultaneous practice and evaluation is possible by connecting multiple simulators to one laptop
- Battery or AC power source



#190634	CPR Simulator	1/each	\$9,500.00
---------	---------------	--------	-------------------

INTRAMUSCULAR INJECTION BUTTOCKS

- Similar to real human skin
- Practice basilic, cephalic, median cubital, and metacarpal veins
- Actual resistance feeling on the skin and venous wall
- Easy installation and replacement of skin pad



#190635	Intramuscular Injection Buttocks	1/each	\$6,000.00
---------	----------------------------------	--------	-------------------



#190902



#190903

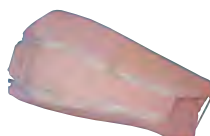

#190909



LATEX FREE

- Easy to use
- Easy care
- Includes storage bag and a link to a full set of instructions

#190902	Adult	1 pair	\$375.00
#190903	Pediatric	1 pair	\$175.00
#190909	Extenders	1/each	\$60.00

NEW PRODUCTS



OtoSim OTOSCOPY TRAINING & SIMULATION SYSTEM

Includes:

- (1) Base unit
- (1) Instrumented otoscope
- (1) Control box
- (1) Adult earform (right ear)
- (1) Adult earform (left ear)
- (1) Software & manual on USB key
- (2) Protective hard cases
- One year warranty

#190608 OtoSim 1/each **\$9,499.00**



OtoSim OPHTHALMOSCOPY TRAINING & SIMULATION SYSTEM

Includes:

- (1) Base unit
- (1) OphthoSim Eye
- (1) Instrumented ophthalmoscope
- (1) Control box
- (1) Software & manual on USB key
- (2) Protective hard cases
- One year warranty

#190613 OphthoSim 1/each **\$9,499.00**

Moullage Concepts BASIC MOULAGE NURSING KIT

Includes:

- "How to Make Your Simulations Come Alive" book
- SIM-Safe (Simulator Safe) series of makeup, simulated vomitus, blood, pus, secretions, and bile mixes
- Packed in a sturdy carrying case

#192002 Basic Moulage Nursing Kit 1/each **\$375.00**



Moullage Concepts ADVANCED MOULAGE NURSING KIT

Includes:

- For the intermediate and advanced moulage designer
- Packed in a sturdy carrying case

#192004 Advanced Moulage Nursing Kit 1/each **\$299.00**

- Create three-dimensional (medical, trauma, obstetrics, and triage) simulated moulage designs

Moullage Concepts DELUXE MOULAGE NURSING KIT

Includes:

- "How to Make Your Simulations Come Alive" book
- Packed in a sturdy carrying case

#192001 Deluxe Moulage Nursing Kit 1/each **\$675.00**

- SIM-Safe (Simulator Safe) series of makeup, simulated vomitus, blood, pus, secretions, and bile mixes

Moullage Concepts NURSING MOULAGE ADD-ON

- Realistic, non-staining, make-up, simulated secretions, bodily fluids and three-dimensional wounds gels

#192003 Nursing Moulage Add-On 1/each **\$199.00**

Patient Care

MEDICAL TAPE



3M LATEX-FREE MICROPORE

- Breathable paper tape
- Gentle adhesion
- Minimal residue
- Tears easily
- Glove friendly

#120784bx	1/2" x 10yds 24/box	\$9.95
#120785bx	1" x 10yds 12/box	\$9.95
#120786bx	2" x 10yds 6/box	\$9.95



3M LATEX-FREE DURAPORE

- Silk-like fabric
- High strength
- Breathable

#120787bx	1/2" x 10yds 24/box	\$14.99
#120788bx	1" x 10yds 12/box	\$14.99
#120789bx	2" x 10yds 6/box	\$14.99
#120790bx	3" x 10yds 4/box	\$14.99



Best
Seller!

3M LATEX-FREE TRANSPORE (Clear)

- Provides superior skin adhesion
- Maximum breathability
- Tears easily
- Plastic, surgical tape

#120781bx	1/2" x 10yds 24/box	\$19.95
#120782bx	1" x 10yds 12/box	\$17.95
#120783bx	2" x 10yds 6/box	\$17.95



LATEX-FREE PAPER SURGICAL

- Provides superior skin adhesion
- Maximum breathability
- Tears easily

#120734bx	1/2" x 10yds 24/box	\$9.95
#120733bx	1" x 10yds 12/box	\$6.95
#120735bx	2" x 10yds 6/box	\$6.95
#120736bx	3" x 10yds 4/box	\$6.95



LATEX-FREE CLOTH SURGICAL

- Strong lightweight construction
- Tears easily without shredding

#120709bx	1/2" x 10yds 24/box	\$10.95
#120708bx	1" x 10yds 12/box	\$10.95
#120711bx	2" x 10yds 6/box	\$10.95
#120710bx	3" x 10yds 4/box	\$10.95



LATEX-FREE PLASTIC SURGICAL

- Stretches and conforms to body contours
- For IV tubing and catheter tape downs

#120752bx	1/2" x 10yds 24/box	\$10.25
#120751bx	1" x 10yds 12/box	\$10.25
#120753bx	2" x 10yds 6/box	\$10.25
#120754bx	3" x 10yds 4/box	\$10.25

SWABS & PREP



Medical Shipment Product

NEW SIMULATED SWABSTICK (Dry)

- (10) Swabsticks per bag
- (10) Bags per box

#8509	10/pack	\$1.94
#8509cs	10/case	\$18.99



Medical Shipment Product

NEW SIMULATED SWABSTICKS WITH DISTILLED WATER

- (3) Swabsticks per pack
- (25) Packs per box

#8508bx	3/pack, 25/box	\$5.90
#8508cs	3/pack, 250/case	\$57.99

Putting Nurses at the Heart of the Solution



3" COTTON TIP APPLICATORS

- (Sterile 2s)
- Sterile applicators packaged in convenient peel-down pouches
 - Bag is autoclavable

#120713pk	100/pack	\$0.73
#120714pk	100/pack	\$0.67
#120717bx	100/box	\$3.75



COTTON BALLS (Non-Sterile)

- For skin prepping and wound cleansing
- Medium size
- General purpose

#120762bg	2000/bag	\$7.75
-----------	----------	---------------



SUNDRY JARS (Set of 5)

- Plastic jars are opaque
- Glass jars are made of flint glass with overlapping stainless steel covers

#120796	Plastic	\$24.90
#120797	Glass	\$39.90

WE ADD THE PERSONAL TOUCH

Patient Care

SWABS & PREP



ALCOHOL SWABSTICKS 3s

- Each swabstick is saturated with 70% isopropyl alcohol

#120763bx 25/box **\$7.45**



POVIDONE IODINE SWABSTICKS

- Saturated with a 10% povidone iodine solution

#120778bx 50/box **\$7.00**



BENZOIN TINCTURE SWABSTICK

- 4"
- Reduces skin irritation
- 77% alcohol

#120902bx 50/box **\$12.99**

POVIDONE IODINE PREP PADS (Medium)

- For antiseptic skin preparation, venipuncture, IV starts, renal dialysis, pre-op prepping
- Pad is saturated with 10% Povidone iodine solution



#120779bx	Povidone Iodine Prep Pads	100/box	\$4.50
#120903bx*	PDI Povidone Prep Pads	100/box	\$6.50

*Not shown



ALCOHOL PREP PADS (Sterile)

#120705bx	Med	200/box	\$2.25
#120706bx	Large	100/box	\$2.75



HYDROGEN PEROXIDE 3%

#120798 1 pint **\$0.90**



ALCOHOL ISOPROPYL

#120799 1 pint **\$2.50**



ALCOHOL DISPENSER

- Polypropylene alcohol dispenser

#120559 8oz **\$8.06**

SWABS & PREP



PVP SCRUB / PREP SOLUTION

- For antiseptic treatment of skin and mucosa
- 10% Povidone iodine, U.S.P.
- Equivalent to 1% available iodine

#120922	Gallon	\$22.50
#120923	16oz	\$3.25



CHLORAPREP AMPULE

- Prevents contamination
- Simplifies scrubbing and hand washing
- Reduces solution waste
- 0.67mL ampule

#120999bx	200/box	\$1.25
-----------	---------	---------------



SCRUB BRUSH WITH 4%

- Includes CHG, PCMX and Povidone Iodine
- Reduces irritation
- Color code Red

#120917	1/each	\$1.60
---------	--------	---------------

Committed to Providing Quality Products



CHLOROPREP LATEX-FREE SWABSTICK

- Rapid acting
- Maintains antimicrobial activity for at least 48 hours
- 5.2mL, 2%
- 3/pack

#120055bx	40/box	\$85.00
-----------	--------	----------------



CHLOROPREP APPLICATOR

- Allows the antiseptic to penetrate into deeper layers of skin
- Formula reduces the chance for infections
- 3mL

#120901	1/each	\$2.49
---------	--------	---------------



PDI IO-GONE REMOVER PADS

- Removes extraneous iodine stains from skin and clothing
- Quickly dissolves residual iodine color

#120905bx	100/box	\$4.50
-----------	---------	---------------

Patient Care

ADHESIVE BANDAGES



CURAD LATEX-FREE PLASTIC (Sterile)

- 3/4" x 2-7/8"

#120793bx 80/box **\$2.50**



CURAD SHEER LATEX-FREE PLASTIC

- 3/4" x 2-7/8"

#120791bx 80/box **\$2.50**



CURAD LATEX-FREE WATERPROOF

- 1" x 3-1/4"

#120792bx 20/box **\$1.99**



FLEXIBLE LATEX-FREE FABRIC STRIPS (Sterile)

- 100/box

#120720bx 3/4" x 3" **\$2.25**

#120718bx 1" x 3" **\$2.25**



SHEER LATEX-FREE ADHESIVE BANDAGES (Sterile)

- 2" x 4-1/2"

#120702bx 50/box **\$3.75**



BUTTERFLY CLOSURES (Sterile)

- 3/8" x 1-13/16"

#120765bx 100/box **\$3.99**



WOUND CLOSURE STRIPS (Sterile)

- 1/8" x 3"
- 5/pouch

#120764bx 50/box **\$29.99**



SKIN PREP PROTECTIVE DRESSING

#120908bx Alcohol 50/box **\$11.75**

#120909bx Non Alcohol 50/box **\$26.99**



PDI ADHESIVE TAPE REMOVER PADS

- Removes adhesive tape from skin

#120904bx 100/box **\$4.25**

GAUZE



COVIDIEN DERMACEA™ GAUZE SPONGES (Non-Sterile)

- 200/bag
- 100% cotton

#120004bg	8-ply 2" x 2"	200/box	\$1.25
#120005bg	8-ply 3" x 3"	200/box	\$2.15
#120006bg	8-ply 4" x 4"	200/box	\$2.75



GAUZE SPONGES (Non-Sterile)

- Singles
- 200/box

#120722bx	8-ply	2" x 2"	\$1.35
#120724bx	8-ply	3" x 3"	\$2.35
#120727bx	8-ply	4" x 4"	\$3.50
#120721bx	12-ply	2" x 2"	\$1.49
#120725bx	12-ply	4" x 4"	\$5.60



CURITY GAUZE SPONGES 2s (Sterile)

- Peel-back package

#120010pk	8-ply (2s)	2" x 2"	50/pack	\$2.99
#120011pk	8-ply (2s)	4" x 4"	25/pack	\$2.99
#120012pk	12-ply (2s)	3" x 3"	25/pack	\$2.75
#120013pk	12-ply (2s)	3" x 3"	25/pack	\$3.50



GAUZE SPONGES (Sterile)

- Highly absorbent
- 100% cotton

#120738bx	8-ply (2s)	2" x 2"	50/box	\$2.49
#120741bx	8-ply (2s)	4" x 4"	25/box	\$2.25
#120739bx	12-ply (2s)	3" x 3"	25/box	\$2.25
#120774	12-ply (2s)	4" x 4"	10/pack	\$0.79
#120740bx	12-ply (2s)	4" x 4"	25/box	\$2.99



NON-WOVEN SPONGE 4-PLY 2s (Sterile)

- Individually wrapped
- Rayon/poly blend

#120042bx	2" x 2"	50/box	\$1.79
#120038bx	3" x 3"	50/box	\$2.50
#120043bx	4" x 4"	25/box	\$1.89



NON-ADHERING DRESSING (Telfa)

- Individually wrapped
- Highly absorbent

#120771bx	2" x 3"	100/box	\$5.99
#120773bx	3" x 4"	50/box	\$7.99
#120772bx	3" x 8"	50/box	\$8.99

Patient Care

GAUZE



NEW CURITY STRETCH BANDAGES

- 75" length

#120014bg	2" Non Sterile	12/bag	\$3.99
#120015bx	3" Non Sterile	12/bag	\$4.99
#120016bx	4" Non Sterile	12/bag	\$7.75
#120018bx	2" Sterile	12/bag	\$6.75
#120019bx	3" Sterile	12/bag	\$8.25
#120020bx	4" Sterile	12/bag	\$9.99



CONFORMING STRETCH

- 4.1 yards stretched
- Self-adhering

#120743bx	2" Non Sterile	12/box	\$1.75
#120744bx	3" Non Sterile	12/box	\$1.90
#120745bx	4" Non Sterile	12/box	\$2.49
#120746bx	6" Non Sterile	12/box	\$2.49
#120747bx	2" Sterile	12/box	\$3.75
#120748bx	3" Sterile	12/box	\$3.99
#120749bx	4" Sterile	12/box	\$4.49



6-PLY GAUZE ROLLS

- 4-1/2" x 4.1yds

#120034cs	Non-Sterile	100/case	\$150.00
#120035cs	Sterile	60/case	\$150.00



KRINKLE 6-PLY GAUZE

- 4-1/2" x 4.1yds

#120728cs	Non-Sterile	100/case	\$79.99
#120729cs	Sterile	100/case	\$89.00



DRAIN SPONGE (Sterile)

- 4" x 4"
- 6-ply

#120758bx	25/box	\$6.49
-----------	--------	---------------



ABD COMBINE PADS (Sterile)

- High absorbency

#120045bx	8" x 10"	15/box	\$2.99
#300105bx	5" x 9"	25/box	\$2.99



OVAL EYEPADS (Sterile)

- 1-5/8" x 2-5/8"
- Soft cotton-fill
- Soft mesh outer cover

#120044bx	100/box	\$5.50
-----------	---------	---------------

ELASTIC BANDAGES & COHESIVES



ELASTIC LATEX-FREE BANDAGES

- Shrink wrapped
- Velcro® premium

#120944	2" x 5'	1/each	\$0.25
#120945	3" x 5'	1/each	\$0.25
#120946	4" x 5'	1/each	\$0.25
#120947	6" x 5'	1/each	\$1.75

ELASTIC LATEX-FREE BANDAGES

- Individually poly-wrapped with 2 clips
- Velcro® premium

#120766	2" x 5'	1/each	\$0.45
#120767	3" x 5'	1/each	\$0.62
#120768	4" x 5'	1/each	\$0.81
#120769	6" x 5'	1/each	\$1.25



3M COBAN™ LATEX-FREE SELF-ADHERENT WRAP (Non-Sterile)

- Tan

#120959cs	2" x 5'	36/case	\$89.00
#120960cs	3" x 5'	24/case	\$79.00
#120961cs	4" x 5'	18/case	\$69.00

COHESIVE LATEX-FREE BANDAGES (Non-Sterile)

- Tan

#120952	1" x 5'	1/each	\$0.89
#120000	2" x 5'	1/each	\$1.50
#120001	3" x 5'	1/each	\$2.50
#120002	4" x 5'	1/each	\$2.50



LATEX-FREE SENSI WRAP (Self Adherent)

- Tan

#120966	1" x 5'	1/each	\$0.99
#120967	2" x 5'	1/each	\$1.50
#120968	3" x 5'	1/each	\$1.99
#120969	4" x 5'	1/each	\$0.35
#120970	6" x 5'	1/each	\$3.99



LATEX-FREE SENSI WRAP

- 6 Colors: Red, Green, Purple, Dark Blue, Pink, Light Blue

#120980	1" x 5'	Rainbow	5/each color	\$0.99
#120981	2" x 5'	Rainbow	6/each color	\$1.50
#120982	3" x 5'	Rainbow	4/each color	\$1.99
#120983	4" x 5'	Rainbow	3/each color	\$2.25
#120984	6" x 5'	Rainbow	2/each color	\$3.99



Patient Care

ADVANCED WOUND CARE



3M TEGADERM TRANSPARENT DRESSING (Sterile)

- Provides a breathable barrier

#120759bx	2-3/8" x 2-3/4"	20/box	\$11.98
#120760bx	4" x 4-3/4"	50/box	\$79.99
#120761bx	6" x 8"	10/box	\$39.25



KENDALL™ POLYSKIN® TRANSPARENT DRESSING

- Allows one-handed application
- Thin, polymer film-coated dressing with a hypoallergenic adhesive

#120780bx	2" x 2-3/4"	100/box	\$36.25
-----------	-------------	---------	----------------



VIEW GUARD TRANSPARENT DRESSING (Sterile)

- Provides a breathable barrier

#120755bx	2-3/8" x 2-3/4"	100/box	\$28.75
#120756bx	4" x 4-3/4"	50/box	\$32.25
#120757bx	6" x 8"	10/box	\$28.49



DYNAGINATE AG-SILVER CALCIUM ALGINATE

- Provides 3 days of continuous antibacterial protection

#120986bx	2" x 2"	10/box	\$15.99
#120985bx	4" x 5"	10/box	\$42.99
#120987bx	4" x 8"	5/box	\$23.99



CURITY PACKING STRIPS (Sterile)

- 1-1/2" x 5yds

#120906	1/each	\$19.99
#120906cs	12/case	\$15.99



MOLNLYCKE MEPITAC SOFT SILICONE TAPE

- For repeated application and removal of tape over the same area

#120910	3/4" x 118"	1/each	\$431.25
#120911	1-1/2" x 59"	1/each	\$14.18

ADVANCED WOUND CARE



3M TEGADERM™ HI & HG ALGINATE DRESSING (Sterile)

- Highly conformable, and absorbent primary wound care dressings
- Use on moderately to heavily exudating wounds

#120988bx	4" x 4"	10/box	\$49.99
#120989bx	12" Rope	5/box	\$32.99



ACTIGUARD - HYDROGEL SHEET

- Used on 1st and 2nd degree burns and skin tears
- Permeable to air & moisture vapor

#120990bx	4" x 4"	10/box	\$27.99
-----------	---------	--------	----------------



COVIDIEN HYDROCOLLOID DRESSING (Sterile)

- For mild exudating wounds

#120995bx	4" x 4"	5/box	\$22.99
#120996bx	6" x 6"	5/box	\$39.99
#120997bx	4" x 5"	5/box	\$39.99



DYNADERM™ HYDROCOLLOID DRESSING

- Can be worn for several days and maintain a moist wound environment

#120991bx	2" x 2"	20/box	\$9.99
#120992bx	4" x 4"	10/box	\$9.99
#120993bx	6" x 6"	5/box	\$13.99
#120994bx	6" x 7"	5/box	\$17.99

MEDIHONEY® HCS BURN DRESSING WITH ACTIVE LEPTOSPERMUM HONEY

- Promotes autolytic debridement and optimize conditions for granulation tissue formation

#120050	1.5 fl oz Applicator	1/each	\$21.99
#120051bx	8" x 12", Sterile	10/box	\$699.00
#120052bx	2-2/5" x 2-2/5" Non-Adhesive	10/box	\$375.00



Patient Care

PERSONAL PROTECTION



Best Seller!

STUDENT PROTECTION KIT

- Includes isolation gown, Blue bouffant cap mask with ties, (1) pair latex-free non-sterile gloves, (1) pair of shoe covers in zip-closure bag

#120801 1/each **\$2.90**



EXAM FACE MASK (with Earloops)

- Blue pleated surgical mask with glass-free filter and earloops

#120104bx 50/box **\$5.99**



LATEX-FREE EXAM FACE MASK (with Ties)

- Blue pleated surgical mask with glass-free filter

#120110bx 50/box **\$5.75**



FACE MASK (Molded)

- Glass-free filter and flared edge
- Dual head straps

#120107bx 50/box **\$8.25**



FACE MASK (with Earloops and Face Shield)

- Glass-free filter and flared edge
- Protects face and eyes from pathogens

#120109bx 50/box **\$28.50**



FACE MASK (with Ties and Face Shield)

- Glass-free filter
- Clear plastic wraparound face shield provides protection for face/eyes

#120111bx 50/box **\$24.25**



FULL LENGTH FACE SHIELDS

- Disposable, anti-fog
- Optically clear polyester
- Soft, elastic headband with foam

#120125 1/each **\$1.99**



SAFETY GLASSES WITH SIDESHIELDS

- Molded side shields and nose bridge
- Meets the requirements of ANSI Z87.1-2010 and CSA Z94.3-2007

#120122 Black 1/each **\$2.49**

#120123 Blue 1/each **\$2.49**



PROTECTIVE GLASSES

- Built-in brow bar and side shields, plus wide view, optical lenses
- Can be worn over prescription eyewear

#120124 1/each **\$2.99**

PERSONAL PROTECTION



BOUFFANT CAPS

- 2" Bouffant-style cap that stays cool
- Soft, elastic headband

#120101bx	100/box	\$5.25
#120117bx	100/box	\$5.95



SURGEON'S CAP

- Lightweight
- Cool, comfortable material
- Soft, elastic headband

#120112bx	100/box	\$16.90
-----------	---------	----------------



LATEX-FREE SHOE COVERS

(Non-Conductive)

- Sewn seams, not glued

#120118cs	300/case	\$19.99
-----------	----------	----------------



DISPOSABLE LATEX-FREE LAB JACKETS

- Waist-length; tear, puncture and penetration-resistant

#120113	Small	1/each	\$1.99
#120114	Medium	1/each	\$1.99
#120115	Large	1/each	\$1.99
#120116	XLarge	1/each	\$1.99



COVERALLS (White)

- Full-length coverall with zippered front closure
- Made of comfortable spunbonded non-woven material

#120119bx	5/box	\$9.99
-----------	-------	---------------



LATEX-FREE ISOLATION GOWN (Yellow)

- Extra length on waist ties so gown can be easily secured in front
- Sewn seams for strength

#120106cs	50/case	\$39.99
-----------	---------	----------------



OPEN BACK ISOLATION GOWN

- Material passes ASTM F1670 test method

#120126	1/each	\$1.99
---------	--------	---------------



SURGEON GOWN

- Constructed of 99% polyester/1% carbon
- Resists fluid penetration

#120128	Large	1/each	\$16.99
#120129	XLarge	1/each	\$19.99



PREVENTION PLUS SURGICAL GOWN

- Made of a breathable, fluid-repellant material
- Extra long, 56"

#120130	Large	1/each	\$6.99
#120131	XLarge	1/each	\$8.99

Patient Care

WIPES, SOAP



WASHCLOTH *(Disposable)*

- Highly absorbent airlaid cellulose material
- Packed in convenient, easy-to-handle poly bags
- 10" x 13"

#120553pk 50/pack **\$2.25**



PERSONAL CLEANSING WASHCLOTH

- Soft, spun lace for soothing, gentle cleansing
- Lanolin and aloe vera conditioners
- Environmentally friendly
- 9" x 13"

#120609pk 64/pack **\$2.99**



ANTISEPTIC TOWELETTES

- Cleans without soap and water
- 5% Alcohol and benzalkonium chloride
- 5" x 7"

#120621bx 100 packets/box **\$1.99**



BABY WIPES *(Scented)*

- Alcohol free for gentle cleansing
- 7" x 8"

#120604 80 Wipes **\$2.99**



BABY WIPES *(Scented)*

- Safe to flush
- Alcohol free
- pH balanced
- 9" x 13"

#120622 60/canister **\$4.99**



NICE 'N FRESH PREMIUM BABY WIPES *(Scented)*

- Alcohol free for gentle cleansing
- 6" x 6-3/4"

#120605 140 Wipes **\$3.99**



METREX VIONEX ANTIMICROBIAL SKIN WIPE TOWELETTES

- Easy hand cleaning when soap and water are not available

#120639bx 50/box **\$10.99**



SANI-HANDS ANTIMICROBIAL WIPES

- Individual packets
- Box or pop-up tub

#120625bx 100/box **\$6.99**

#120626 135/tub **\$8.99**



DIAL ANTIMICROBIAL LIQUID SOAP

- Added skin conditioners
- Broad antimicrobial effectiveness

#120607 16oz Pump **\$5.99**

#120631 Gallon **\$9.99**

Purell HAND SANITIZERS



TFX™ TOUCH FREE DISPENSER

- Holds 1200mL refills

#120646 1/each **\$15.99**



TFX™ FOAM HAND SANITIZER

- 1200mL Refill
- Works with #120646

#120647 1/each **\$39.99**



TFX™ INSTANT HAND SANITIZER

- 1200mL Refill
- Works with #120646

#120648 1/each **\$19.50**



Dispenser and refills sold separately

TFX™ UNIVERSAL MOUNT & FLOOR STAND

- Free-standing unit or wall mount

#120649 Wall Mount **\$49.99**

#120650 Floor Stand **\$79.99**



FOAMING DISPENSER KIT

- PURELL® Foaming Hand Sanitizer, 15oz aerosol canister

#120653 Kit **\$13.99**

#120652 Dispenser Only **\$4.99**



TFX™ FOAM HAND SANITIZER

- 15oz Refill
- Latex & CHG compatible, dye free
- Works with #120652

#120651 1/each **\$13.99**



SURGICAL SCRUB TFX™ TOUCHLESS DISPENSER

- 30,000 Uses from 3 standard "C" alkaline batteries which are included

#120654 1/each **\$19.99**



SURGICAL SCRUB TFX™

- 1200mL Refill
- Works with #120654

#120655 1/each **\$199.00**



INSTANT HAND SANITIZER

- 12oz Pump bottle
- Works in 15 seconds

#120632 1/each **\$6.99**

Patient Care

DISINFECTANT



SUPER SANI-CLOTH GERMICIDAL WIPES

- Where control of cross-contamination is of prime importance
- EPA approved; high alcohol (55%)

#120619	160/tub		\$10.99
---------	---------	--	----------------



Most Popular!

Lysol DISINFECTANT SPRAY

(Original Scent)

- Formula is tuberculocidal, virucidal, fungicidal and bactericidal

#120635	19oz	1/each	\$10.99
---------	------	--------	----------------



Meets the requirements of the OSHA

Lysol DISINFECTANT SPRAY (IC)

- Formula is tuberculocidal, virucidal, fungicidal and bactericidal

#120637	19oz	1/each	\$10.99
---------	------	--------	----------------



Lysol FOAMING DISINFECTANT CLEANER (IC)

- Kills 99.9% of germs on hands, nonporous surfaces within 30 seconds

#120638	24oz	1/each	\$5.99
---------	------	--------	---------------



CAVICIDE SURFACE DISINFECTANT

- Intermediate-level disinfectant
- Kills TB in 3 minutes and HBV, HCV, and HIV in 2 minutes

#120640	24oz	1/each	\$10.99
#120641	Gallon	1/each	\$29.99



METRI-CIDE 28 SOLUTION

- Can be used and reused as a sterilant and high-level disinfectant for up to 28 days

#120642	Quart	1/each	\$10.99
#120643	Gallon	1/each	\$22.99

PERSONAL CARE, HAIR & NAIL



MANICURE ORANGE STICKS

- Flat end for pushing back cuticles; pointed end for cleaning
- 4.5" long

#120529bx 144/box **\$2.99**



FINGERNAIL CLIPPERS

- Manufactured from high quality steel

#120519 1/each **\$0.99**



EMERY BOARDS

- For intricately shaping and filing fingernails and toenails
- 4.5" long

#120518bg 12/bag **\$0.75**



HAIRBRUSH (Ivory)

- Adult
- 86 tuft

#120517 1/each **\$0.75**



7" COMB (Black)

- Adult
- 7" length

#120516bg 12/bag **\$1.50**



NAIL POLISH REMOVER PADS

- For the removal of nail polish
- Contains no acetone

#120558bx 100/box **\$4.50**



NAIL FILE

- Stainless steel
- 5" Long

#120550bx 12/box **\$8.75**

Patient Care

PERSONAL CARE, ORAL CARE



Best Value!



FLAVORED SWABSTICKS

- Lemon glycerin solution refreshes patients with dry mouths

#120527	1/each	\$0.15
#120527bg	250/bag	\$35.00
#120527cs	1000/case	\$129.00

ORAL SWABSTICKS

- Gently cleans and moistens; raised foam ridges

#120523	1/each	\$0.10
#120523bg	250/bag	\$24.99
#120523cs	1000/case	\$84.99

DENTURE TABLETS

- Kills bacteria and dissolves tough stains

#120522bx	40/box	\$1.50
-----------	--------	---------------



TOOTHBRUSH

- Individually sealed in clear poly bag
- Flat plastic handle, 30 tuft

#120521	1/each	\$0.15
#120521bx	144/box	\$18.50



TOOTHPASTE

- Contains fluoride
- Individually boxed

#120543	1/each	\$0.30
---------	--------	---------------

NEED TO CREATE A PURCHASE ORDER? IT'S AS EASY AS 1, 2, 3:

1. Choose your items online
2. Click "Add to Quote" box
3. Give shipping details & receive your quote instantly!



DENTURE BRUSH

- Ideal for bedside storage
- Firm plastic bristles

#120548	24/box	\$0.50
---------	--------	---------------



DENTURE CUP

- Ideal for bedside storage
- Lid imprinted for labeling

#120549	1/each	\$0.35
---------	--------	---------------



FLEX STRAWS

- Individually wrapped

#120535bx	400/box	\$2.90
-----------	---------	---------------

PERSONAL CARE



SHAVING CREAM

- Thick and rich lather

#120544*	1.5oz can	\$0.95
#120545	11oz can	\$1.65

*Not shown



STICK DEODORANT

- Soothing
- Non-irritating

#120613	1.5oz stick	\$0.50
---------	-------------	---------------



AQUELL MOISTURIZING LOTION

- 16oz Pump
- White lotion

#120601	1/each	\$10.99
---------	--------	----------------



BABY POWDER

- Stay cool and fresh throughout the day

#120627	14oz/bottle	\$0.60
#120628	14oz/bottle	\$1.90



PETROLATUM JELLY (Foil Pack)

- Treats and prevents diaper rash
- Seals out wetness

#120795bx	144/box	\$9.99
-----------	---------	---------------



WHITE PETROLATUM

- Treats and prevents diaper rash
- Seals out wetness

#120563	15oz	\$4.50
---------	------	---------------



BABY OIL

- Soothing and non-irritating
- Helps relieve dryness

#120629	4oz/bottle	\$0.99
#120630	12oz/bottle	\$1.99



BULB SYRINGE (Sterile)

- Disposable for aspiration & irrigation

#120580	1/each	\$1.50
---------	--------	---------------



EMESIS BASIN

- For oral hygiene and ear irrigation

#120551	1/each	\$0.99
---------	--------	---------------

Patient Care

PERSONAL CARE



ADULT BRIEFS

- Super-absorbent polymer
- Sturdy re-fastenable tape tabs ensure a secure fit
- Blue dryness strip provides optimum skin protection

#120560	Medium	32"-44"	1/each	\$0.65
#120561	Large	45"-58"	1/each	\$0.75
#120562	XLarge	59"-64"	1/each	\$1.05



PANTY LINERS

- Highly absorbent liners
- Adhesive strip holds liner in place

#12054bx	4" x 11"	25/box		\$2.50
----------	----------	--------	--	---------------



DISPOSABLE UNDERPADS

- Waterproof, non-skid Blue backing
- Not biodegradable

#120540bx	17" x 24"	100/box		\$12.99
#120540cs	17" x 24"	300/case		\$26.49
#120541cs	23" x 36"	150/case		\$34.99



PERINEUM WASH

- No rinse cleanser for incontinent care

#120623	8oz Pump Bottle	\$0.99
#120624	Gallon	\$9.99



PERINEAL INSTANT COLD PACK WITH SELF ADHESIVE STRIP

- For gentle, effective postpartum care

#120577	1/each	\$1.25
---------	--------	---------------



PERSONAL CLEANSING WASHCLOTH

- Gentle, alcohol free
- 9" x 13"

#120610	46/tub	\$2.75
---------	--------	---------------



INFLATABLE CUSHION RING

- For relief of patient discomfort following OB/Gyne or proctological surgical procedures

#120575	1/each	\$3.75
---------	--------	---------------



CLEANSING ENEMA SET

- Clean out the contents of the bowels and flush away waste in the colon
- Castile soap

#120590	1/each	\$1.50
---------	--------	---------------



MINERAL OIL ENEMA

- For relief of constipation

#120546	1/each	\$1.99
#120547	Saline Laxative	\$0.95
#121102	Enema Bag Set	\$2.75

PERSONAL CARE

ADMISSION KIT

Kit comes shrink-wrapped in a 6 quart wash basin and includes:

- 17oz Emesis basin
- 4oz Hand and body lotion
- 4oz Alcohol-free mouthwash
- Pitcher with handle & lid
- 0.64oz Deodorant bar soap
- Soap dish with ridges, 3-3/4" x 2-3/4" x 0.5"
- Individually wrapped 30 tuft adult toothbrush
- Fluoride toothpaste 0.6oz
- 9oz Tumbler



#120557 1/each **\$5.99**

DISPOSABLE PATIENT GOWN

- Ideal for routine exams and office procedures
- Universal size
- Includes ties



#120120cs 50/case **\$19.99**

DISPOSABLE EXAM CAPE

- Durable, soft cape can be worn with opening in front or back
- Covers upper body



#120121cs 100/case **\$17.49**

LATEX-FREE SLIPPER SOCKS (Large)

- Anti-slip surfaces provide enough traction to prevent sliding
- Lightweight, soft, cotton knit provides optimal warmth and comfort



#120127 1 pair **\$1.50**

PATIENT DRAWSTRING BAG

- White plastic bag with a drawstring
- Write patients name and room number on the bag



#120556 1/each **\$0.50**

Patient Care

PERSONAL CARE



DISPOSABLE 3-PLY TOWEL DRAPES (Sterile)

- Cost-effective compared to cloth
- Absorbent

#120311bx	Fenestrated	18" x 26"	50/box	\$14.75
#120312bx	Plain	18" x 26"	50/box	\$12.95



TABLE PAPER (Smooth or Crepe)

- Superior performance and economy

#120320	Crepe	18" x 125'	1 roll	\$2.50
#120321	Crepe	21" x 125'	1 roll	\$2.75
#120305	Smooth	18" x 225'	1 roll	\$3.25
#120306	Smooth	21" x 225'	1 roll	\$3.50



MEDICINE CUP

- Strong flexible virgin polypropylene
- Easy-to-read graduations

#120533pk	1oz	100/pack	\$1.25
#120534bx	5oz	100/box	\$2.50



PAPER SOUFFLE CUP

- Features tightly rolled edges and box pleats to ensure stability and rigidity
- Works well in conjunction with pill crushers for clean and simple pill crushing

#121131bx	0.75oz	250/box	\$3.99
-----------	--------	---------	---------------



DENTAL BIBS

- 17-3/4" x 12-7/8"

#121132cs	White	500/case	\$19.99
#121133cs	Blue	500/case	\$19.99
#121134cs	Mint Green	500/case	\$19.99
#121135cs	Mauve	500/case	\$19.99
#121136cs	Lavender	500/case	\$19.99

Need Help with a Product?

Contact Us **1-855-MED-SHIP**

FIRST AID, EMS



DYNA STOPPER TRAUMA DRESSING

- Sterile
- Unfolds for extra coverage
- 3-1/2" x 5-1/2"

#121111	2/pack	\$1.99
---------	--------	---------------



Hot

Cold

Most Popular!

INSTANT PACKS

- Easy activation

#120530	Hot	5" x 9"	\$0.75
#120531	Cold	5" x 9"	\$0.75
#120579	Cold with Urea	5" x 9"	\$0.99



ACTISPLINT™ MULTI-PURPOSE UNIVERSAL SPLINT

- Comfortable
- Easy to mold
- Lightweight

#121113	Rolled	1/each	\$7.25
#121114	Flat	1/each	\$7.25

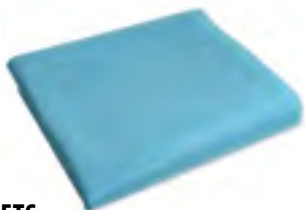

COT SHEETS

- Soft and breathable
- Fluid and tear resistant
- Premium

#170423	Fitted	1/each	\$0.99
#170426	Flat	1/each	\$0.99



BURN SHEET

- Sterile
- Packed in airtight poly pack
- Provides emergency first aid for burn victims

#170427	1/each	\$3.99
---------	--------	---------------



EMERGENCY RESCUE BLANKET

- Mylar foil material
- Folded to compact size
- One-time use

#120914	1/each	\$0.99
---------	--------	---------------



CADAVER BAG

- Includes post mortem bag, straight zipper, adult, (3) tags
- 36" x 90"

#121115	Cadaver Bag	\$9.99
#121116	Shroud Kit	\$2.50



BIOHAZARD BAG

- With tie
- Red
- 12" x 6" x 18"

#121117cs	1000/case	\$89.99
-----------	-----------	----------------



STAINLESS STEEL BANDAGE SHEARS

- Cuts clothing and seat belts
- Available in Magenta, Orange, Purple, Red, Teal and Yellow

#121118	Black	1/each	\$1.50
#121119	Blue	1/each	\$1.50
#121126	3.5" Mini	1/each	\$0.75

Patient Care

FIRST AID KITS

DELUXE 25-PERSON FIRST AID KIT

Includes 162 pieces

- (15) BZK antiseptic towelettes
- (6) First aid/burn cream packs, 0.9g
- (6) Antibiotic ointment packs, 0.9g
- (100) 1" x 3" Adhesive plastic bandages
- (2) Knuckle fabric bandages
- (2) Fingertip fabric bandages
- (1) 5" x 9" Trauma pad
- (8) 3" x 3" Gauze dressing pads, (4) 2-pks
- (1) First aid guide
- (1) 40" x 40" x 56" Triangular sling/ bandage, with 2 safety pins
- (1) 1/2" x 10 yards First aid tape roll
- (1) 3" Conforming gauze
- (1) 4" x 5" Instant cold compress
- (4) Exam quality vinyl gloves
- (1) 4-1/2" Scissors, nickel plated
- (1) 4" Tweezers, plastic, one time use
- (1) Metal case



#120913	Deluxe 25-Person First Aid Kit	\$29.25
---------	--------------------------------	---------



#120047

#120046

PEDIATRIC 3-SHELF STATION

- Solution for schools, day care centers and summer camps
- Heavy gauge steel cabinet with sturdy welded construction
- Baked enamel; acid and rust resistant finish
- 14-3/4" W x 16" H x 5-1/2" D

#120046	Pediatric 3-Shelf Station	1/each	\$99.00
---------	---------------------------	--------	---------

PEDIATRIC FIRST AID KIT

- Rugged, moisture and dent resistant plastic case
- Carrying handle with built in wall mounting bracket
- 9-1/4" W x 9-1/4" H x 2-2/4" D

#120047	Pediatric First Aid Kit	1/each	\$47.50
---------	-------------------------	--------	---------

TRIPLE ANTIBIOTIC OINTMENT

#120633bx	9g	144/box	\$17.50
#120634	1oz	1/each	\$2.50



TRIANGULAR BANDAGES

#121127	36" x 36" x 51"	1/each	\$0.60
#121128	40" x 40" x 56"	1/each	\$0.60



AMMONIA INHALANT

#120555bx	0.33cc	10/box	\$2.50
-----------	--------	--------	--------



FOLEY, CATHETER



#8501

Medical Shipment Product



#8502

NEW FOLEY CATHETER KIT (Non-Sterile Swab)

Packed as if sterile for educational purpose

- (1) Foley urethral catheter
- (1) 2000mL Drainage bag
- Pre-connected foley with (5)mL balloon
- (1) Syringe, 10mL, pre-filled with sterile water
- (2) Medium latex-free vinyl gloves, powder-free
- (1) Underpad moisture-proof
- (1) Prep deck

- (1) Fenestrated drape, absorbent
- (2) Packs simulated swabsticks with distilled water
- (1) Rubber band and bed sheet clamp
- (1) Lubricating jelly packet
- (1) Urine collection vial with cap and label
- (1) Tamper evident seal

#8501	5cc	14Fr	1/each	\$9.99
#8502	5cc	12Fr	1/each	\$9.99



KENDALL DOVER LATEX FOLEY TRAY

Includes:

- CSR wrapped tray
- 2000mL Drain bag
- Absorbent underpad
- (1) Pair of nitrile gloves
- Fenestrated drape
- Prepping balls
- Lubricant syringe 10g
- Specimen container (with label)
- 10mL Prefilled syringe
- Latex catheter with Ultramer hydrogel coating

#120426	14Fr	1/each	\$11.75
#120447	16Fr	1/each	\$14.50



SILICONE ELASTOMER-COATED CLOSED FOLEY TRAY

Includes:

- Compartmentalized tray
- Wrapped Aloetouch 3G gloves
- (3) PVP swabsticks
- Underpad
- Fenestrated drape
- 10mL Sterile water syringe & lube jelly
- Specimen container with label
- CSR wrap
- 400mL Urine meter
- 2500mL Drain bag

#120430	14Fr	1/each	\$8.75
#120431	16Fr	1/each	\$9.50
#120432	18Fr	1/each	\$10.50

Patient Care

FOLEY, CATHETER



CLOSED CIRCUIT FOLEY CATHETER TRAY (Sterile)

- Foley catheter 12, 14, 16 or 18Fr, 5cc
- (1) 2000mL Drainage bag
- (1) Bed sheet clamp
- (1) Pre-filled sterile water syringe 10cc
- (1) Lubricating jelly
- (1) Waterproof drape
- (1) Fenestrated drape
- (1) Pair vinyl powder-free gloves (medium)
- (3) 3 PVP swabsticks pack
- (1) Specimen container and label

#120433	12Fr /tray	1/each	\$7.95
#120434	14Fr /tray	1/each	\$7.95
#120435	16Fr /tray	1/each	\$7.95



FOLEY LATEX-FREE INSERTION TRAY KIT (Sterile)

Includes:

- (1) Graduated collection basin
- (1) Underpad
- (1) Prefilled sterile water syringe
- (1) Lubricating jelly
- (3) PVP swabsticks
- (1) Fenestrated drape
- (1) Pair cuffed powder-free vinyl gloves

#120437	Catheter Plug and Tube Tip Protector	1/each	\$2.99
#120438		1/each	\$2.99



For smooth operation of hinged instruments

KENDALL LATEX-FREE CATHETER INSERTION TRAY

Includes:

- Fenestrated drape
- Underpad
- Nitrile gloves (1 pair)
- Graduated basin
- Lubricating jelly
- Specimen container and label
- Universal catheterization tray
- Prepping components (benzalkonium chloride swabsticks)
- 10mL Prefilled syringe

#120428	Insertion Tray	1/each	\$4.99
---------	----------------	--------	---------------

URETHRAL CATHETERIZATION TRAY (Sterile)

Includes:

- (1) Graduated collection basin
- (1) Underpad
- (1) 14Fr Red rubber catheter
- (1) Lubricating jelly
- (3) PVP swabsticks
- (1) Fenestrated drape
- (1) Pair cuffed powder-free vinyl gloves
- (1) Specimen container with lid and label

#120436	Urethral Catheterization Tray	1/each	\$2.99
---------	-------------------------------	--------	---------------



FOLEY, CATHETER/ CENTRAL LINE DRESSING

CATHETER/SYRINGE ADAPTER (Sterile)

- Disposable connector for attaching syringe to tubing
- Packaged sterile in individual wrap

#120441 Catheter/Syringe Adapter 1/each **\$0.79**



CATHETER PLUG AND TUBE TIP PROTECTOR (Sterile)

- Disposable plug for catheters and flexible tubing with tip protector
- Provides quick-acting plug for all flexible tubing, with lumina from 3 mm (1/8") to 9mm (3/8"), including standard 7mm (9/32")

#120576 Catheter Plug and Tube Tip Protector 1/each **\$0.79**



DRESSING CHANGE TRAY

- (1) Tray
- (1) Polylined drape
- (1) Polybag with twist tie
- (1) 1" x 36" Plastic tape
- (1) Transfer forcep
- (1) 5" x 9" Abdominal pad
- (1) 2" Safety pin
- (1) 3-pack Simulated swabsticks
- (4) 4" x 4" Gauze dressing

#8504 Dressing Change Tray 1/each **\$3.09**



CENTRAL LINE LATEX-FREE DRESSING TRAY WITH CHLORAPREP

Includes:

- Chloraprep applicator, 3mL
- Isopropyl alcohol swabstick
- 2" x 2" Non-adhering dressing
- 2" x 2" Gauze dressing
- 4" x 4" Gauze dressing
- Dressing change label
- 2" x 2" Non-adhering split dressing
- Mask
- Medical tape (roll)
- Pair of gloves
- ChloraPrep®
- 4" x 4-3/4" Tegaderm™ dressing

#120210 Central Line Tray with Chloraprep 1/each **\$6.99**



CENTRAL LINE LATEX-FREE DRESSING TRAY WITH TEGADERM

Includes:

- Mask
- Pair of gloves
- Povidone iodine ointment
- 2" x 2" Gauze dressing
- 2" x 2" Non-adhering dressing
- (3) Iodopher PVP swabsticks
- 4" x 4" Gauze dressing
- Medical tape (roll)
- (3) Isopropyl alcohol swabsticks
- Dressing change label
- CSR wrap
- 2" x 2" Non-adhering split dressing
- 4" x 4-3/4" Tegaderm™ transparent

#120211 Central Line Tray with Tegaderm 1/each **\$8.95**



Patient Care

CENTRAL LINE DRESSING



CENTRAL LINE LATEX-FREE DRESSING TRAY (with Saline and Stretch Gauze)

Includes:

- Three-compartment tray
- Pair gloves
- Polylined sterile field drape
- Abdominal pad
- (8) 4" x 4" Gauze sponges
- Medical ruler
- 100mL Sterile saline solution
- Medical tape (roll)
- Polybag with twist tie
- Sharp/blunt scissors
- Stretch gauze dressing
- Dressing change label

#120212	Central Line Dressing Tray	1/each	\$6.99
---------	----------------------------	--------	---------------



DRESSING CHANGE TRAY WITH INSTRUMENTS & ABDOMINAL PAD (Sterile)

Includes:

- Polylined sterile field drape
- Abdominal pad
- (4) Gauze sponges 4" x 4" (triples)
- Safety pin
- Iodophor PVP swabstick
- Medical tape (roll)
- Sharp/blunt scissors
- Polybag with twist tie
- Transfer forceps
- Posi-Grip™ plastic forceps

#120213	Dressing Change Tray	1/each	\$5.15
---------	----------------------	--------	---------------



DRESSING CHANGE TRAY WITH TEGADERM

Includes:

- (1) Instructions for use
- (1) Wound care tray
- (1) Non-woven face mask
- (1) Non-woven split sponge, 2" x 2", 4 ply
- (1) Non-adherent sponge, 2" x 2"
- (1) Gauze sponge, 2" x 2", 8 ply
- (1) Gauze sponge, 4" x 4", 8 ply
- (1) Dressing change label
- (1) Waterproof drape, 45 x 35cm
- (1) PVC gloves, size M, powder free, White, with wallet
- (1) Tape measure, 36"
- (3) PVP swabsticks
- (3) Alcohol swabsticks
- (1) Roll transparent dressing tape
- (1) Transparent dressing, 4" x 4-3/4"

#120209	Dressing Change Tray with Tegaderm	1/each	\$3.99
---------	------------------------------------	--------	---------------

CENTRAL LINE DRESSING/KITS

CENTRAL LINE DRESSING TRAYS

Includes:

- Alcohol swabs (3 pack)
- PVP swabs (3 pack)
- PVP ointment
- Split gauze 2" x 2"
- (4) Gauze sponges
- Framed transparent dressing
- Scissors
- Curad Tape
- Latex-free gloves
- Towel/drape
- Bag with tie
- CSR wrap



#120201	Central Line Dressing Trays	1/each	\$5.99
---------	-----------------------------	--------	---------------

CENTRAL LINE DRESSING TRAYS

Includes:

- Chloraprep (3mL)
- (2) Gauze sponges 2" x 2"
- Framed transparent dressing
- Tape
- Latex-free gloves
- Towel/drape
- Dressing change label
- Ruler

#120203	With Suresite	1/each	\$5.25
#120204	With Sureview	1/each	\$4.99
#120205	With Tegaderm	1/each	\$4.99



We Add the Personal Touch!

CENTRAL LINE DRESSING CHANGE TRAYS

Includes:

- Mask
- Alcohol swab, 1-pack
- Chloraprep 3ml applicator
- (2) Gauze sponges 4" x 4"
- Transparent dressing with border
- Tape
- Pair of Aloetouch® latex-free gloves
- Towel/drape
- Dressing change label

#120206	Central Line Dressing Trays	1/each	\$18.99
---------	-----------------------------	--------	----------------

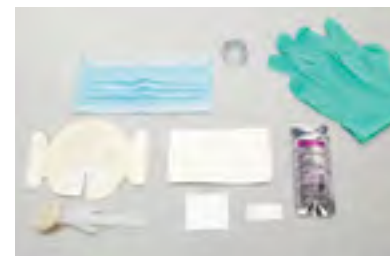

Patient Care

CENTRAL LINE DRESSING/KITS



CENTRAL LINE DRESSING CHANGE TRAYS

Includes:

- (2) Gauze 2" x 2" 4-ply dressings
- Gauze 2" x 2" 6-ply non-woven split dressing
- 4-1/2" x 4" Suresite® window dressing
- Alcohol swabstick (1 pk)
- Skin prep wipe
- 1.6mL Chlorascrub
- Mask
- Cotton tip applicator
- Tape

#120207	Suresite	1/each	\$3.99
#120208	Tegaderm	1/each	\$4.75



STAPLE REMOVER KIT (Sterile)

Includes:

- Staple remover (stainless steel)
- Gauze sponge
- Removable Tyvek lid

#120921	Staple Remover Kit	1/each	\$1.49
---------	--------------------	--------	---------------



SUTURE REMOVAL KIT

Includes:

- Littauer scissors
- Gauze sponge
- 4" Metal forceps

#120920	Suture Removal Kit	1/each	\$1.49
---------	--------------------	--------	---------------



SHAVE PREP TRAY

Includes:

- Razor with stainless steel blade
- Waterproof drape
- Soap impregnated sponge
- Single compartment tray
- Absorbent towel
- (2) Cotton-tipped applicators

#120918	Shave Prep Tray	1/each	\$1.75
---------	-----------------	--------	---------------

KITS

OBSTETRICAL KIT *(Bagged)*

- (1) Pair sterile latex exam gloves
- (6) Sterile gauze sponges
- Underpad
- Sterile bulb syringe
- Sterile disposable scalpel
- (2) Sterile umbilical clamps
- Sterile OB pad
- (2) Alcohol preps, medium
- Drape sheet
- Plastic bag to hold placenta
- Receiving blanket
- (2) OB towelettes
- (4) Disposable towels
- (2) Twist ties & nylon tie-offs

#120915	Obstetrical Kit	1/each	\$8.50
---------	-----------------	--------	---------------



CHEMO SPILL KIT

Spill kits for clean-up and containment of chemotherapy spills include:

- Mask and maximum protection gown
- (2) Pair latex-free gloves
- (1) Pair shoe covers
- Dust/Mist respirator
- (1) Pair wraparound goggles
- Caution sign
- Scoop and brush set
- (3) Absorbent towels
- (2) Spill control pillows
- Exposure Report form and more...

#120916	Chemo Spill Kit	1/each	\$34.99
---------	-----------------	--------	----------------



LAPAROSCOPY SURGICAL TRAY *(Sterile)*

- (4) Adhesive, woven bandages
- Emesis basin
- 32oz Graduated bowl
- CPC connector
- 4oz Specimen container
- 2oz Medicine cup
- Lap chole drape with troughs
- (4) Utility drapes with tape
- Fog reduction device
- (10) Gauze, 4" x 4"
- (2) Sirius nonreinforced gowns, XL, (1) with ABS towel
- Foam/Magnetic needle counter
- Scalpel Holder
- Skin/Utility marker, ruler & labels
- Strip-Medi, 5/card
- Syringe, 10mL
- (2) Suction tubing
- (9) Blue OR towels
- Transfer tray

#170149	Laparoscopy Surgical Tray	1/each	\$69.99
---------	---------------------------	--------	----------------



SURGICAL FAVORITE

DYNALUBE LUBRICATING JELLY

- Provides lubrication for hinged instruments

#120776	2oz tube	1/each	\$1.25
#120775	4oz tube	1/each	\$1.45
#120777bx	2.7g packet	1/each	\$6.99



Patient Care

SURGICAL



DISPOSABLE SCALPELS *(Gamma sterilized)*

- Individually foil packaged
- Sheffield stainless steel blade
- For guaranteed sharpness and exacting performance

#170150bx	Size 10	10/box	\$6.75
#170134bx	Size 11	10/box	\$6.75
#170135bx	Size 12	10/box	\$6.75
#170136bx	Size 15	10/box	\$6.75
#170137bx	Size 20	10/box	\$6.75
#170138bx	Size 21	10/box	\$6.75
#170139bx	Size 22	10/box	\$6.75
#170140bx	Size 23	10/box	\$6.75

DISPOSABLE SURGICAL BLADES

- Individually foil packaged
- Sheffield stainless steel blade
- Plastic blade guard can be replaced after use

#170141bx	Size 10	100/box	\$15.95
#170142bx	Size 11	100/box	\$15.95
#170143bx	Size 12	100/box	\$15.95
#170144bx	Size 15	100/box	\$15.95
#170145bx	Size 20	100/box	\$15.95
#170146bx	Size 21	100/box	\$15.95

DISPOSABLE SCALPEL WITH SAFETY LOCK *(Gamma Sterilized)*

- Blade retracts with one simple motion and can be permanently locked
- Sheffield stainless steel blade for exacting performance
- Packaged in individual pouches

#170151bx	Size 10	100/box	\$8.49
#170147bx	Size 11	100/box	\$8.49
#170148bx	Size 15	100/box	\$8.49

SCALPELS, SCISSORS, FORCEPS



5" HALSTED MOSQUITO FORCEPS

#120500	1/each	\$3.99
---------	--------	---------------



LISTER BANDAGE SCISSORS

- Stainless steel

#300117	5-1/2"	\$2.90
#120599	7-1/4"	\$3.50



5-1/2" KELLY HEMOSTATIC FORCEPS

#120502	Straight	\$3.50
#300121*	Curved	\$3.50

*Not shown



STAINLESS STEEL SPONGE BOWL

- Seamless construction
- 4-1/2" W x 2" D

#170133	1/each	\$7.99
---------	--------	---------------



STAINLESS STEEL KICK BUCKET

- Bucket pours easily without removal from stand
- Vinyl covered ring on stand prevents marring of walls and floors

#170132	1/each	\$139.00
---------	--------	-----------------



STAINLESS INSTRUMENT TRAY

- 12-1/8" x 7-5/8" x 2-1/8"

#170131	1/each	\$36.00
---------	--------	----------------

Patient Care

FEEDING PUMPS & SETS



KENDALL KANGAROO EPUMP ENTERAL PUMP

- Latest innovation in enteral feeding pump technology
- For patients who require nutrition through continuous feeding, intermittent feeding or feeding and flushing

#170201	Kangaroo ePump	\$649.00
---------	----------------	-----------------



KENDALL KANGAROO EPUMP SET PROXIMAL DEHP-FREE SPIKE FEED/FLUSH

- For use with Kangaroo Joey #170202) and the Kangaroo ePump #170201
- Incorporates the internal Anti-Free Flow (AFF) Device for continuous protection for the patient

#170205	Proximal Spike Feed/Flush	1000mL	\$8.99
---------	---------------------------	--------	---------------



KENDALL KANGAROO 924 ENTERAL FEEDING PUMP

- Features pre-set volume and overflow infusion safeguards
- Easy-to-use controls make set-up and operation of the unit intuitive

#170203	Kangaroo 924 Pump	\$550.00
---------	-------------------	-----------------

#170207	924 Pump Set	\$3.75
---------	--------------	---------------



KENDALL JOEY ENTERAL PUMP

- Provides feeding and flushing in a completely portable device
- Pump is the first hydrating and ambulatory enteral device

#170202	Joey Pump	\$798.00
---------	-----------	-----------------

#120594	Spike Pump Set with 1000mL Flush Bag	\$9.25
---------	--------------------------------------	---------------



KENDALL KANGAROO EPUMP™ AND JOEY SPIKE SET (Sterile)

- Anti-free flow 1000mL
- No DEHP

#120595	ePump Set	\$8.50
---------	-----------	---------------



KENDALL PROXIMAL SPIKE SET (Non-Sterile)

- Individually packed

#120596	Spike Set	\$2.99
---------	-----------	---------------

FEEDING PUMPS & SETS

KENDALL KANGAROO JOEY PUMP SETS (Non-Sterile)

#170206	Pump Set with Flush Bag Anti-free Flow 1000mL	1/each	\$9.99
#170219	Pump Set Anti-free Flow 1000mL	1/each	\$3.99



ENTERAL DELIVERY GRAVITY BAG SET

Includes:

- 1200cc Enteral bag
- Drip chamber
- Tubing
- Roller clamp
- Feeding set adapter with protective cap
- Not designed for use with a pump

#170204	Enteral Delivery Gravity Bag Set	1/each	\$1.85
---------	----------------------------------	--------	---------------



ENTERAL FEEDING SYRINGE WITH POLE BAG SET (Non-Sterile)

Includes:

- 60cc Enteral feeding piston syringe has a precision crafted o-ring
- Non-sterile syringes are packed in poly bags which can be hung from iv pole
- Works with #170202

#120598	Enteral Delivery Gravity Bag Set	1/each	\$0.75
---------	----------------------------------	--------	---------------



IRRIGATION TRAY WITH BULB SYRINGE SET

Includes:

- 1000cc Outer basin tray
- Bulb syringe
- Protective cap
- Waterproof drape
- Antiseptic wipe
- 500cc Plastic graduate

#120536	Irrigation Tray, Bulb Syringe Set	1/each	\$1.50
---------	-----------------------------------	--------	---------------

#120539	Bulb Syringe Only, 60cc	1/each	\$0.99
---------	-------------------------	--------	---------------



IRRIGATION TRAY WITH PISTON SYRINGE SET

Includes:

- 500cc Plastic graduate
- 1000cc Outer basin tray
- Piston bulb syringe
- Protective cap
- Waterproof drape
- Antiseptic wipe

#120537	Irrigation Tray, Piston Syringe Set	1/each	\$1.50
---------	-------------------------------------	--------	---------------

#120538	Piston Syringe Only, 60cc	1/each	\$0.99
---------	---------------------------	--------	---------------



Patient Care

SCD



KENDALL 6325 RESPONSE SCD (Reconditioned)

- Includes Kendall 6325 tubing set
- Sleeves sold separately

#170602	Kendall 6325 Response SCD	1/each	\$599.99
#121103pr	Medium SCD Knee Length Sleeve	1/pair	\$69.00
#121100pr	Large SCD Knee Length Sleeve	1/pair	\$97.00
#121101pr	Small Thigh Length	1/pair	\$99.00
#121104pr	Medium Thigh Length	1/pair	\$99.00
#121105pr	Large Thigh Length	1/pair	\$119.00

KENDALL 7325 RESPONSE SCD (Reconditioned)

- Offers a clinician the option of two different prophylactic methods with one controller; leg compression and foot compression
- Battery operation makes the device transportable
- Includes Kendall 7325 tubing set
- Sleeves sold separately

#170601	Kendall 7325 Response SCD	1/each	\$699.00
#121103pr	Medium SCD Knee Length Sleeve	1/pair	\$69.00
#121100pr	Large SCD Knee Length Sleeve	1/pair	\$97.00
#121104pr	Small Thigh Length	1/pair	\$99.00
#121101pr	Medium Thigh Length	1/pair	\$99.00
#121105pr	Large Thigh Length	1/pair	\$119.00

KENDALL 9525 RESPONSE SCD (Reconditioned)

- Offers a clinician the option of two different prophylactic methods with one controller; leg compression and foot compression
- Battery operation makes the device transportable
- Includes Kendall 9525 tubing set
- Sleeves sold separately

#121106	Kendall 9525 Response SCD	1/each	\$1,899.00
#121107pr	Medium SCD Knee Length Sleeve	1/pair	\$69.00
#121108pr	Large SCD Knee Length Sleeve	1/pair	\$99.00
#121109pr	Medium Thigh Length	1/pair	\$99.00
#121110pr	Large Thigh Length	1/pair	\$119.00

PATIENT LIFT

EASY LIFT PATIENT SIT TO STAND LIFTING SYSTEM

- Heavy-gauge steel construction
- Adjustable knee pad unit
- 24V DC motor allows quiet, smooth operation
- Accessory storage bag included for slings and charger

#170509	600 lb Capacity	1/each	\$2,999.00
#170508	400 lb Capacity	1/each	\$2,500.00



DELUXE SIT-TO-STAND PADDED SLING

- Works with #170509 and #170508

#170510	Small Sling	1/each	\$299.00
#170511	Medium Sling	1/each	\$299.00
#170512	Large Sling	1/each	\$299.00
#170513	XX Large	1/each	\$335.00



EASY LIFT PATIENT LIFTING SYSTEM

#170503	Easy Lift Patient Lifting System, 400 lb	\$1,999.00
#170504	Bariatric Easy Lift Patient Lifting System, 600 lb	\$2,999.00
#170505	Medium Sure-Lift Universal Sling	\$159.00
#170506	Large Sure-Lift Universal Sling	\$159.00
#170507	XL Sure-Lift Universal Sling	\$159.00



Simplify Your Ordering Process
medicalshipment.com

Patient Care

AMBULATORY



WHEELCHAIR WITH FOOTRESTS

- Tool free adjustable front rigging
- Hammer tone paint provides a long lasting and durable finish
- Two position axle and caster fork provides 2" seat height adjustment
- Limited 1 year warranty

#120566	Traveler SE Wheelchair	\$399.00
#120564	With Swingaway Footrests	\$250.00
#120565	With Elevating Footrests	\$299.00



ALUMINUM CRUTCHES

- Push button adjustment
- Height adjustment in 1" increments
- Maximum weight capacity 300 lb

#120567	Adult	\$19.99
#120568	Tall	\$19.99
#120569	Youth	\$19.99



FOLDING WALKER WITH 5" CASTERS

- Rear glide tips to facilitate use on all surfaces
- Sturdy 1" aluminum tubing provides maximum strength while remaining lightweight
- One year limited warranty

#120573	Deluxe Walker	\$31.99
#120574	Folding Walker	\$29.99



QUAD CANE

- Offset handle places the user's weight over the base for maximum balance and control
- Height adjusts from 29" to 38" in 1" increments
- Three year limited lifetime warranty

#120570	Small Base Quad Cane	\$17.99
#120571	Large Base Quad Cane	\$19.99



ADJUSTABLE OFFSET CANE (Silver)

- Available in a variety of finishes, grip styles and lengths
- Includes laminated color operating instructions
- Limited lifetime warranty

#120572	Adjustable Offset Cane	\$9.99
#120581	Aluminum Adjustable Cane	\$8.90

AMBULATORY

Prose EZ CLEAN ECONOMY GAIT/TRANSFER BELT

- "2" Biothane® polyurethane webbing wipes clean
- Easy to use airline-style buckle

#120511 EZ Clean Economy Gait Transfer Belt 1/each **\$19.99**



Prose ADD-ON GAIT BELT HANDLES (Black)

- Vertical hand grip for better support
- Fits 2" gait belts
- Ergonomic handles provide a firmer handhold

#120515 Add-on Gait Belt Handles 1/each **\$13.99**



Prose STANDARD GAIT BELT

- Navy blue gait belt with nickel buckle
- Fits sizes up to 51"

#121130 Standard Gait Belt 1/each **\$14.99**



Prose QUICK-RELEASE BARIATRIC GAIT BELT

- Fits waist sizes: Up to 72" (183cm)
- 2" (5 cm) wide webbing
- Machine washable
- Weight capacity of 279 lbs. (127kgs)

#121129 Bariatric Gait Belt 1/each **\$21.99**



Prose ERGONOMIC WALKING BELT

- For ambulation and/or transfer assistance
- Medium

#120509 Ergonomic Walking Belt 1/each **\$69.99**



Prose BED CRADLE AND FOOT SUPPORT

- Four-piece sturdy steel frame
- Fits standard hospital or nursing home beds

#120513 Bed Cradle and Foot Support 1/each **\$69.99**



GAIT BELT (White with Blue and Red Pinstripes)

- Cotton belts aid caregivers as they assist patients

#120505 Gait Belt 1/each **\$8.50**



Carts

Defibrillators
ECGs

Diagnostics

Gloves

Hospital
Beds

Infusion

Labels

Manikins
Simulators

Media

Monitors

New
Products

Patient
Care

Patient
Room

Practice
Meds

PYXIS®

Respiratory

Student
Kits

Syringes

Training
Headwall
Units

Patient Room

EXAM TABLES



CALL 1-847-253-3000
For Refurbished
 Midmark 104
 Ritter 630
 Power Procedure Chair

RITTER MANUAL EXAM TABLE

- (3) Side drawers
- Ergonomic top design
- Additional weight capacity

#170123 1/each **\$1,499.00**



**GOOSENECK
EXAM LAMP**

- Heavy gauge, anodized aluminum shade
- Height range 34-1/2" to 53-1/2"

#170125 1/each **\$119.00**



WE ADD THE PERSONAL TOUCH



PEDIATRIC WITH DIGITAL SCALE AND LOCK

- (2) All metal drawers
- Padded front rail for infant safety
- Digital scale, 50lb patient weight capacity
- Three year limited warranty

#170121 1/each **\$2,799.00**



BARIATRIC EXAM TABLE

- All-steel heavy duty construction
- Four large, full extension drawers on roller bearing drawer guides
- Upholstery color options
- 800lb (363 kg) Weight capacity
- Three year limited warranty

#170152 1/each **\$3,299.00**



ELEMENT TREATMENT TABLE

- Steel frame construction
- Configuration options available
- 500lb Weight capacity
- Three year warranty

#170124 1/each **\$1,199.00**

BLOOD DRAW CHAIRS, STOOLS



DESIGNER BLOOD DRAWING CHAIR WITH DRAWER

- Features a padded seat and back, with drawer storage cabinet
- Flip-up contoured urethane armrest provides easy access & superior safety
- All colors available
- 300lb Weight capacity

#170111	1/each	\$485.00
---------	--------	-----------------



BLOOD DRAWING CHAIR WITH STORAGE CABINET

- Two infinitely adjustable armrests
- Flip-up contoured urethane armrest provides easy access & superior safety
- 300lb Weight capacity

#170108	No Cabinet	\$425.00
#170112	With Cabinet	\$499.00



RECLINING CHAIR WITH TABLE

- Features as 5" total lock casters, non-porous blow-molded tray with removable locking function, headrest and heavy gauge expanded vinyl
- 275lb Weight capacity

#170113	1/each	\$699.00
---------	--------	-----------------



HEAVY DUTY FOOT STOOL & HANDRAIL

- Platform topped with non-skid, ribbed mat
- Equipped with reinforced rubber tips
- 350lbs Weight capacity

#170155	Foot Stool with Handrail	\$49.99
#170155	Foot Stool Only	\$49.99



GAS LIFT STOOL

- 16" Seat is made of 3" high density foam and covered with heavy-gauge vinyl
- 250lb Weight capacity
- Available in Blue Ridge and Black

#170116	Lift Stool	\$150.00
#170117	Lift Stool with Footring	\$199.00



LAB CHAIR-HIGH BENCH

- Adjustable height and tilt backrest
- Chrome-plated foot ring & gas cylinder
- Nylon casters
- Includes footring

#170154	Lift Stool with Footring	\$275.00
---------	--------------------------	-----------------

Patient Room

IV POLES, SCREENS

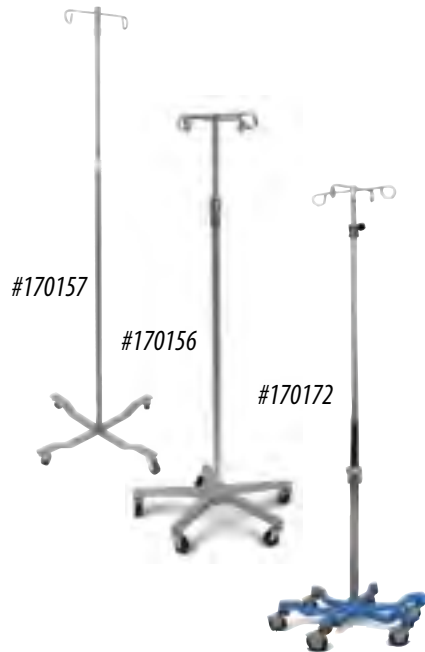

FOUR-LEG STANDARD IV POLE

- Chrome-plated steel

#170157	4-Leg IV Pole	\$55.00
---------	---------------	----------------

FIVE-LEG DELUXE IV POLE (4 Hook)

- Chrome-plated stainless steel
- 2" Nylon swivel casters

#170156	5-Leg IV Pole	\$99.00
---------	---------------	----------------

SIX-LEG HEAVY-DUTY IV POLE (4 Hook)

- Extra stable cast iron base
- Adjusts from 73"-99-1/2"

#170172	6-Leg IV Pole	\$299.00
---------	---------------	-----------------



B3-PANEL FOLDING SCREEN (Economy)

- 360° Swivel and infinite connectivity
- One year warranty against manufacturer defects

#170118	1/each	\$139.00
---------	--------	-----------------



3-PANEL SCREEN WITH 2" TWIN WHEEL CASTERS

- Wall mounted
- 180° range of motion

#170119	1/each	\$199.00
---------	--------	-----------------



TELESCOPING CURTAIN

- Powder-coated steel

#170120	1/each	\$199.00
---------	--------	-----------------

SHARPS CONTAINERS

SHARPS CONTAINERS WITH SHARPSTAR LID (Red)

#120336	2 gallon	1/each	\$9.49
#120337	3 gallon	1/each	\$10.90
#120338	4 gallon	1/each	\$14.25

SHARPS CONTAINERS WITH SLIDING & SEALING LIDS (Red)

#120339	8 gallon with Sliding Lid	1/each	\$17.90
#120340	12 gallon with Sliding & Sealing Lid	1/each	\$25.25

PHLEBOTOMY PLASTIC CONTAINER

- Accommodates a variety of Sharps
- Temporary closure for security
- Lids lock for safe transport and disposal

#120342	1 quart	1/each	\$2.80
---------	---------	--------	---------------

TRANSPORTABLE SHARPS CONTAINER

#120341	1 quart	1/each	\$5.05
---------	---------	--------	---------------

IN-ROOM SYSTEM WALL ENCLOSURE & GLOVE BOX

#120343	5 quarts	1/each	\$25.00
---------	----------	--------	----------------

BD PATIENT ROOM SHARPS COLLECTOR

#120344	5.4 quarts	1/each	\$46.99
---------	------------	--------	----------------



Patient Room

DISPENSERS



#170162



#120323



#170164



#170163



#170165



#120324

BOWMAN® PRODUCTS PROTECTION ORGANIZERS

#170162	Holds Gowns, (2) Boxes of Gloves, (1) Box of Face Mask & (1) Box of Face Shields	\$169.00
#120323	Holds Flat Pack or Launderable Gowns, (3) Boxes of Gloves, (1) Box of Face Masks & (1) Box of Face Shields	\$189.00
#170160*	Over-the-Door Hanger Clip	\$34.99
#170161*	Clip On Sign Holder	Holds 8-1/2" x 11" page \$22.99

*not shown

BOWMAN® RESPIRATORY HYGIENE

- Holds (2) boxes of face masks, (2) boxes of facial tissue, and (1) hand sanitizer bottle or hand sanitizing wipe canister

#170163	Hygiene Station	1 Station	\$89.99
#170164	Floor Stand	Holds A Variety Of Respiratory Hygiene Stations, Hardware Included	\$149.00
#170165	Sign Holder	Holds 11" W x 8-1/2" H Signs	\$21.99

BOWMAN® INFECTION PREVENTION ORGANIZER/STATION

- Holds (2) boxes of face masks, one - (2) boxes of facial tissue, and (1) hand sanitizer bottle or hand sanitizing wipe canister

#170166	Hygiene Station	1 Station	\$99.99
---------	-----------------	-----------	----------------

BOWMAN® GLOVE BOX DISPENSERS

- Screw holes for wall mounting

#170168	Holds 2 Boxes of Gloves	1 Station	\$54.99
#170169	Holds 3 Boxes of Gloves	1 Station	\$34.20

BOWMAN® GLOVE DISPENSER

- Vertical or horizontal wall mountable
- White-powder coated steel
- Two-way keyholes
- Holds most standard glove boxes

#120322	1 Box Dispenser	1/each	\$16.78
#120324	4 Box Dispenser	1/each	\$53.95

LINENS



INFANT LINEN PACKAGE

Package Includes:

- Receiving blanket, white with pink/blue border (30" x 40")
- White cotton kuddle-up thermal blanket (30" x 40")
- White newborn knit booties
- Newborn multi-stripe knit cap

#170406	Infant Pkg	\$21.50
#170409	Receiving Blanket	\$4.50
#170410	Thermal Blanket	\$15.00
#170412	Newborn Booties 1/pair	\$1.25
#170413	Newborn Multi-Stripe Knit Cap	\$0.60



BED LINEN PACKAGE

Package Includes:

- White percale draw sheet (54" x 72")
- White percale fitted bed sheet (36" x 80" x 9")
- Flat muslin bed sheet (66" x 104")
- White cotton/poly pillow case

#170408	Bed Linen Pkg	\$27.99
#170418	Draw Sheet	\$6.50
#170419	Fitted Sheet	\$9.25
#170420	Flat Sheet	\$11.99
#170421	Pillow Case	\$2.99



BATHING PACKAGE

Package Includes:

- Unbleached cotton/poly bath blanket (70" x 90")
- White cotton terry bath towel (24" x 40")
- Cotton terry hand towel (16" x 27")
- (2) Cotton terry washcloths (11" x 11")

#170407	Bathing Pkg	\$19.99
#170414	Bath Blanket	\$8.50
#170415	Bath Towel	\$8.50
#170416	Hand Towel	\$2.75
#170417	Washcloth	\$0.99

Need a Help with a Product??

Contact Us 1-855-MED-SHIP



NEWBORN MULTI-STRIPE CAP & WHITE BOOTIES

- Soft, warm knit

#170413	Knit Cap	\$0.65
#170412	Knit Booties 1/each	\$1.25



THERMAL BLANKET

- Made of cotton and polyester blend
- 66" x 96"

#170422	1/each	\$14.50
---------	--------	----------------



INFANT WOVEN FITTED SHEET

- White cotton crib sheet
- 28" x 52"

#170411	1/each	\$12.99
---------	--------	----------------

Practice Meds

PYXIS® PRACTICE MEDS STARTER KIT

PYXIS® PRACTICE MEDS STARTER KIT

- To be used with the Pyxis MedStation and Console
- Med Starter Kit includes all the practice meds regularly prescribed (listed below, in the dosages and units typically used)
- Includes capsules, tablets, bottles and vials (66 total)

#181301 Pyxis Practice Meds Starter Kit **\$349.00**

AMOXICILLIN	mg Bottle (1)
AMOXICILLIN/POT. CLAV.	mg Bottle (1)
TRAINING OPHTHALMIC DROPS	Bottle (1)
ACTIVE CHARCOAL	25gm, Bottle (1)
ALUMINUM HYDROXIDE CONC	30 Liq. Cup - U/D (5)
PREDNISON	5mg 5 Liq. Cup - U/D (10)
ACETAMINOPHEN LIQUID	160mg 5 Liq. Cup - U/D (5)
ALBUTEROL SULFATE	5mg 5mL Neb. Vial (10)
PROCHLORPERAZINE EDISYLATE	10mg 2mL PFS (5)
HEPARIN SODIUM PORCINE	6000 Units 0.5mL PFS (5)
MORPHINE SULFATE	10mg 1mL PFS (5)
MORPHINE SULFATE	30mg 30 PFS (5)
DIAZEPAM	5mg 1mL PFS (5)
ZOLPIDEM CR	6.25mg Tab/Cap - U/D (5)
ASPIRIN	325mg Tab/Cap - U/D (5)
LORAZEPAM	1mg Tab/Cap - U/D (5)
ASPIRIN	81mg Tab/Cap - U/D (5)
CAPTOPRIL	50mg Tab/Cap - U/D (5)
CAPTOPRIL	25mg Tab/Cap - U/D (5)
DILTIAZEM	120mg Tab/Cap - U/D (5)
CIPROFLOXACIN HCL	500mg Tab/Cap - U/D (5)
DOCUSATE SODIUM	100mg Tab/Cap - U/D (5)
DOCUSATE SODIUM	50mg Tab/Cap - U/D (5)
WARFARIN	10mg Tab/Cap - U/D (5)
WARFARIN	2.5mg Tab/Cap - U/D (5)
WARFARIN	5mg Tab/Cap - U/D (5)
PREDNISON	10mg Tab/Cap - U/D (5)
PHENYTOIN	100mg Tab/Cap - U/D (5)
METFORMIN	500mg Tab/Cap - U/D (5)
CEPHALEXIN	250mg Tab/Cap - U/D (5)
DIGOXIN	0.25mg Tab/Cap - U/D (5)
FUROSEMIDE	20mg Tab/Cap - U/D (5)
ATORVASTATIN CALCIUM	10mg Tab/Cap - U/D (5)



METOPROLOL	50mg Tab/Cap - U/D (5)
HYDROCODONE/APA	5/500mg Tab/Cap - U/D (5)
BENAZEPRIL	20mg Tab/Cap - U/D (5)
IBUPROFEN	200mg Tab/Cap - U/D (5)
OXYCODONE HCL	10mg Tab/Cap - U/D (5)
HYDROCODONE/APAP	5/325mg Tab/Cap - U/D (5)
DIPYRIDAMOLE	75mg Tab/Cap - U/D (5)
PROPRANOLOL HCL	10mg Tab/Cap - U/D (5)
PANTOPRAZOLE	40mg Tab/Cap - U/D (5)
TEMAZEPAM	15mg Tab/Cap - U/D (5)
LEVOTHYROXINE	100mcg Tab/Cap - U/D (5)
ACETAMINOPHEN W/COD	30mg Tab/Cap - U/D (5)
ACETAMINOPHEN	325mg Tab/Cap - U/D (5)
BUPROPRION	100mg Tab/Cap - U/D (5)
ONDANSETRON HCL	8mg Tab/Cap - U/D (5)
ERYTHROMYCIN	250mg Tab/Cap - U/D (5)
FERROUS SULFATE	65mg Tab/Cap - U/D (5)
MVI - MULTIVITAMIN	Tab/Cap - U/D (5)
POTASSIUM	20mEq Tab/Cap - U/D (5)
CEFAZOLIN SODIUM	1g 10mL Vial (5)
DIPHENHYDRAMINE HCL	50mg 1mL Vial (5)
HYDROMORPHONE HCL	1mg 1mL Vial (5)
DOBUTAMINE	500mg 20mL Vial (5)
INSULIN REG HUMAN	1000 Units 10mL Vial (5)
MORPHINE SULFATE	2mg 1mL Vial (5)
PROMETHAZINE	25mg 1mL Vial (5)
LORAZEPAM	2mg 1mL Vial (5)
EPINEPHRINE	1:1000 1mL Vial (5)
HEPARIN SODIUM	1,000 Units 10mL Vial (5)
HEPARIN SODIUM	10,000 Units 5mL Vial (5)
50% DEXTROSE	50mL Vial (5)
TRAINING POWDER Y	Vial (5)
TRAINING POWDER 2G	2gm Vial (5)

TRAINING TABLET/CAPSULE PACKS

	#180635pk	Acetaminophen 325mg 50/pack	\$16.95		#180604pk	Aspirin 325mg 50/pack	\$16.95
	#181424pk	Acetaminophen 500mg 50/pack	\$16.95		#180685pk	Atenolol 50mg 50/pack	\$16.95
	#181425pk	Acetaminophen 650mg 50/pack	\$16.95		#180687pk	Atenolol 100mg 50/pack	\$16.95
	#180634pk	Acetaminophen/ Codeine 30mg 50/pack	\$16.95		#180622pk	Atorvastatin Calcium 10mg 50/pack	\$16.95
	#180606pk	Acetylsalicylic Acid 81mg 50/pack	\$16.95		#180625pk	Benazepril 20mg 50/pack	\$16.95
	#180681	Acetylsalicylic Acid 81mg (ASA) 100/bottle	\$23.98		#180636pk	Bupropion 100mg 50/pack	\$16.95
	#180643pk	Acyclovir 250mg 50/pack	\$16.95		#181426pk	Candesartan Cilexetil 8mg 50/pack	\$16.95
	#180642	Acyclovir 250mg 100/bottle	\$23.98		#180608pk	Captopril 25mg 50/pack	\$16.95
	#180683pk	Amitriptyline HCl 10mg 50/pack	\$16.95		#180690pk	Captopril 12.5mg 50/pack	\$16.95
	#180682	Amitriptyline HCl 10mg 100/bottle	\$23.98		#181427pk	Captopril 6.25mg 50/pack	\$16.95
	#180645pk	Amoxicillin 500mg 50/pack	\$16.95		#180607pk	Captopril 50mg 50/pack	\$16.95
	#180644	Amoxicillin 500mg 100/bottle	\$23.98		#180619pk	Cephalexin 250mg 50/pack	\$16.95
					#180647pk	Cephalexin 500mg 50/pack	\$16.95

Practice Meds

TRAINING TABLET/CAPSULE PACKS

	#180646	Cephalexin 500mg 100/bottle	\$23.98		#180620pk	Digoxin 0.25mg 50/pack	\$16.95
	#180649pk	Chlordiazepoxide 5mg 50/pack	\$16.95		#181434pk	Digoxin 0.125mg 50/pack	\$16.95
	#180648	Chlordiazepoxide 5mg 100/bottle	\$23.98		#180609pk	Diltiazem 120mg 50/pack	\$16.95
	#180610pk	Ciprofloxacin HCL 500mg 50/pack	\$16.95		#180654	Diltiazem 120mg 100/bottle	\$23.98
	#180651pk	Clindamycin 150mg 50/pack	\$16.95		#180629pk	Dipyridamole 75mg 50/pack	\$16.95
	#180650	Clindamycin 150mg 100/bottle	\$23.98		#180656pk	Disopyramide 25mg 50/pack	\$16.95
	#180652	Clindamycin 25mg 100/bottle	\$23.98		#180655	Disopyramide 25mg 100/bottle	\$23.98
	#180653pk	Clomipramine 25mg 50/pack	\$16.95		#180611pk	Docusate Sodium 100mg 50/pack	\$16.95
	#181429pk	Clozapine 25mg 50/pack	\$16.95		#180612pk	Docusate Sodium 50mg 50/pack	\$23.98
	#181430pk	Codeine 60mg 50/pack	\$16.95		#180693pk	Enalapril Maleate 2.5mg 50/pack	\$16.95
	#181431pk	Dexamethasone 4mg 50/pack	\$16.95		#180695pk	Enalapril Maleate 5mg 50/pack	\$16.95
	#181433pk	Diazepam 5mg 50/pack	\$16.95		#180694	Enalapril Maleate 5mg 100/bottle	\$23.98
	#181432pk	Diazepam 10mg 50/pack	\$16.95		#180638pk	Erythromycin 250mg 50/pack	\$16.95

TRAINING TABLET/CAPSULE PACKS

	#180639pk	Ferrous Sulfate 65mg 50/pack	\$16.95		#181410pk	Hydrochlorothiazide 25mg 50/pack	\$16.95
	#180658pk	Fexofenadine 60mg 50/pack	\$16.95		#180628pk	Hydrocodone/APAP 5/325mg 50/pack	\$16.95
	#180657	Fexofenadine 60mg 100/bottle	\$23.98		#180624pk	Hydrocodone/APAP 5/500mg 50/pack	\$16.95
	#180697pk	Fluoxetine 10mg 50/pack	\$16.95		#180626pk	Ibuprofen 200mg 50/pack	\$16.95
	#180696	Fluoxetine 10mg 100/bottle	\$23.98		#181412pk	Isosorbide Dinitrate 10mg 50/pack	\$16.95
	#180699pk	Folic Acid 1mg 50/pack	\$16.95		#180660pk	Labetalol 100mg 50/pack	\$16.95
	#180698	Folic Acid 1mg 100/bottle	\$23.98		#180659	Labetalol 100mg 100/bottle	\$23.98
	#180621pk	Furosemide 20mg 50/pack	\$16.95		#180633pk	Levothyroxine 100mg 50/pack	\$16.95
	#181401	Furosemide 20mg 100/bottle	\$23.98		#181414pk	Lisinopri 2.5mg 50/pack	\$16.95
	#181403	Furosemide 40mg 100/bottle	\$23.98		#181413	Lisinopri 2.5mg 100/bottle	\$23.98
	#181406pk	Glipizide 5mg 50/pack	\$16.95		#180605pk	Lorazepam 1mg 50/pack	\$16.95
	#181408pk	Glyburide 3mg 50/pack	\$16.95		#181436pk	Lorazepam 2mg 50/pack	\$16.95
	#181435pk	Glyburide 10mg 50/pack	\$16.95		#181416pk	Meloxicam 15mg 50/pack	\$16.95

Practice Meds

TRAINING TABLET/CAPSULE PACKS

	#181415	Meloxicam 15mg 100/bottle	\$23.98		#181439pk	Omeprazole 40mg 50/pack	\$16.95
	#180618pk	Metformin 500mg 50/pack	\$16.95		#180637pk	Ondansetron HCL 8mg 50/pack	\$16.95
	#181418	Metformin 500mg 100/bottle	\$23.98		#181440pk	Oxycodone 2mg 50/pack	\$16.95
	#181437pk	Metoprolol 25mg 50/pack	\$16.95		#180627pk	Oxycodone HCL 10mg 50/pack	\$16.95
	#180623pk	Metropolol 25mg 50/pack	\$16.95		#181441pk	Oxycodone Hydrochloride 10mg 50/pack	\$16.95
	#180662pk	Minocycline 100mg 50/pack	\$16.95		#180631pk	Pantoprazole 40mg 50/pack	\$16.95
	#180661	Minocycline 100mg 100/bottle	\$23.98		#181442pk	Perindopril 4mg 50/pack	\$16.95
	#181438pk	Morphine Sulfate ER 30mg 50/pack	\$16.95		#180666pk	Phenytoin 30mg 50/pack	\$16.95
	#180640pk	MVI-Multivitamin 30mg 50/pack	\$16.95		#180665	Phenytoin 30mg 100/bottle	\$23.98
	#181417	Nitroglycerin 0.4mg 100/bottle	\$23.98		#180617pk	Phenytoin Sodium 100mg 50/pack	\$16.95
	#180664pk	Nortriptyline HCl 25mg 50/pack	\$16.95		#180668pk	Piroxicam 20mg 50/pack	\$16.95
	#180663	Nortriptyline HCl 25mg 100/bottle	\$23.98		#180667	Piroxicam 20mg 100/bottle	\$23.98

TRAINING TABLET/CAPSULE PACKS

	#180641pk	Potassium 20mEq 50/pack	\$16.95		#181423pk	Sodium Fluoride 5mg 50/pack	\$16.95
	#180670pk	Prazosin HCl 5mg 50/pack	\$16.95		#181422	Sodium Fluoride 5mg 100/bottle	\$23.98
	#180669	Prazosin HCl 5mg 100/bottle	\$23.98		#181444pk	Sulfamethoxazole 800mg/ Trimethoprim/ 160mg 50/pack	\$16.95
	#180616pk	Prednisone 10mg 50/pack	\$16.95		#180632pk	Temazepam 15mg 50/pack	\$16.95
	#181421pk	Prednisone 5mg 50/pack	\$16.95		#180675	Tetracycline 250mg 100/bottle	\$16.95
	#181420	Prednisone 5mg 100/bottle	\$23.98		#180676pk	Tetracycline 250mg 50/pack	\$16.95
	#180672pk	Procainamide 250mg 50/pack	\$16.95		#181445pk	Thiamine 100mg 50/pack	\$16.95
	#180630pk	Propranolol HCL 10mg 50/pack	\$16.95		#181446pk	Venlafaxine HCl 25mg 50/pack	\$16.95
	#181443pk	Ramipril 5mg 50/pack	\$16.95		#180614pk	Warfarin 2.5mg 50/pack	\$16.95
	#180674pk	Rifampin 300mg 50/pack	\$16.95		#180615pk	Warfarin 5mg 50/pack	\$16.95
	#180673	Rifampin 300mg 100/bottle	\$23.98		#180613pk	Warfarin 10mg 50/pack	\$16.95
					#180603pk	Zolpidem CR 6.25mg 50/pack	\$16.95

Need a Custom Medication?
Contact Us 1-855-MED-SHIP



Practice Meds

FLAVORS

	#181601	Bubblegum	30mL	1/each	\$5.76		#181613	Strawberry	30mL	1/each	\$5.76
	#181602	Bubblegum	120mL	1/each	\$15.84		#181614	Strawberry	120mL	1/each	\$15.84
	#181603	Cherry	30mL	1/each	\$5.76		#181615	Tutti Frutti	30mL	1/each	\$5.76
	#181604	Cherry	120mL	1/each	\$15.84		#181616	Tutti Frutti	120mL	1/each	\$15.84
	#181605	Creme de Menthe	30mL	1/each	\$5.76		#181617	Vanilla	30mL	1/each	\$5.76
	#181606	Creme de Menthe	120mL	1/each	\$15.84		#181618	Vanilla	120mL	1/each	\$15.84
	#181607	Grape	30mL	1/each	\$5.76		#181619	Watermelon	30mL	1/each	\$5.76
	#181608	Grape	120mL	1/each	\$15.84		#181620	Watermelon	120mL	1/each	\$15.84
	#181609	Pina Colada	30mL	1/each	\$5.76	<div style="text-align: center;"> <h3>TEN DIFFERENT FLAVORS</h3>  <p>Flavor Variety Pack • 10 Flavors</p> </div>					
	#181610	Pina Colada	120mL	1/each	\$15.84						
	#181611	Root Beer	30mL	1/each	\$5.76						
	#181612	Root Beer	120mL	1/each	\$15.84	#181622	(10) 120mL bottles			\$142.68	
						#181621	(10) 30mL bottles			51.48	

PREFILLED SYRINGES

A	#181205pk	Diazepam Injection 160mg/5mL	5/pack	\$9.98
B	#181204pk	Morphine Sulfate Injection 4mg/mL, 1mL	5/pack	\$9.98
C	#181203pk	Morphine Sulfate Injection 10mg/mL, 1mL	5/pack	\$9.98
D	#181202pk	Heparin Sodium Procaine Injection 5,000units/mL, 1mL	5/pack	\$9.98
E	181201pk	Prochlorperazine Edisylate 10mg/2mL, 2mL	5/pack	\$9.98
F	#181207pk	Atropine Sulfate 0.1mg/mL 10mL	5/pack	\$11.98
G	#181208pk	Calcium Chloride 100mg/mL 10mL	5/pack	\$11.98
H	#181209pk	Dextrose 50% 50mL	5/pack	\$14.98

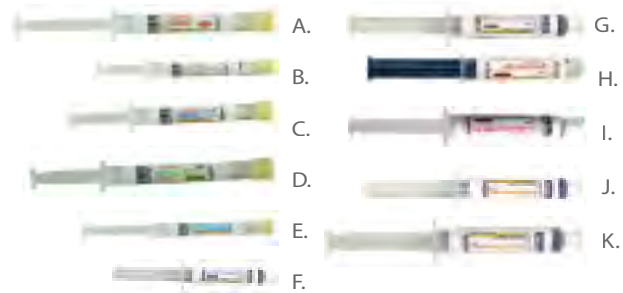

I	#181210pk	Lidocaine HCl 2% 20mg/mL, 5mL	5/pack	\$10.98
J	#181211pk	Sodium Bicarbonate 4.2% (Infant) 10mL	5/pack	\$11.98
K	#181212pk	Sodium Bicarbonate 4.2% (Adult) 210mL	5/pack	\$11.98



EDUCATIONAL STARTER KIT

Vials

- (1) Box of mini vials 25 x 2mL
- (1) Box of small vials 25 x 5mL
- (1) Box of medium vials 25 x 10mL
- (1) Box of large vials 16 x 20mL
- (1) Box of large vials 9 x 30mL
- (1) Box of x-large vials 9 x 50mL
- (1) Box of powder vials (Clear) 25 x 3g
- (1) Box of powder vials (Yellow) 25 x 3g
- (1) Box of hazardous vials 25 x 10mL
- (1) Box of hazardous powder vials 25 x 300mg
- (1) Box of multi-insulin pack 40 x 10mL
- (1) Box of Heparin pack 18 x 5mL; 18 x 10mL

Ampules

- (2) Packages of sterile water in glass ampules 25 x 2mL
- (2) Packages of sterile water in glass ampules 25 x 5mL

Capsules

- (18) Unique pharmacy stock bottles 100 count of various capsules
- (2) Unique pharmacy stock bottles 500 count of various capsules

Tablets

- (17) Unique pharmacy stock bottles 100 count of various tablets
- (2) Unique pharmacy stock bottles 500 count of various capsules

Liquids

- (3) Unique pharmacy stock bottles 480mL of various liquids

Antibiotic Suspensions for Reconstitution

- (18) Bottles of Amoxicillin 150mL
- (18) Bottles of Amoxicillin Potassium Clavulanate 100mL
- (18) Bottles of Cefprozil 75mL

Creams & Ointments

- (20) Tubes of different creams and ointments in varying stock sizes

Ophthalmic, Otic & Nasal Preparations

- (5) Bottles of ophthalmic drops
- (5) Bottles of otic drops
- (5) Bottles of nasal spray

Flavor Variety Pack

- (10) 1oz Bottles of various flavors 10 x 30mL

#181816

\$1,995.00

Practice Meds

VIALS



#180838pk **Acyclovir**
500mg 25/pack **\$43.15**



#180847pk **Ciprofloxacin**
200mg 16/pack **\$32.98**



#180839pk **Adenosine**
6mg/2mL 25/pack **\$34.20**



#180848pk **Cladribine**
1mg/ml 25/pack **\$43.15**



#180840pk **Amiodarone HCl**
150mg/3mL 25/pack **\$36.60**



#180849pk **Dexamethasone Sodium**
4mg/mL 25/pack **\$34.20**



#180902pk **Amoxicillin**
150mL 6/pack **\$24.60**



#180818pk **Dextrose Injection 50%**
25grams, 0.5g/mL 9/pack **\$25.98**



#180842pk **Anthromycin**
500mg 25/pack **\$43.15**



#180850pk **Diatrizoate Meglumine & Diatrizoate Na**
370mg/mL 9/pack **\$25.98**



#180841pk **Atropine Sulfate**
1mg/mL 25/pack **\$34.20**



#180851pk **Diltiazem HCl**
25mg/5mL 25/pack **\$36.60**



#180843pk **Bevacizumab**
400mg/16mL 20mL 25/pack **\$32.98**



#180852pk **Dimenhydrinate**
2mg/mL 25/pack **\$34.20**



#180844pk **Calcium Chloride 10%**
100mg/mL, 10mL 25/pack **\$43.15**



#180809pk **Diphenhydramine HCl (High Potency)**
50mg/mL 25/pack **\$34.20**



#180845pk **Calcium Gluconate**
100mg/mL 25/pack **\$43.15**



#180810pk **Dobutamine**
250mg/20mL 16/pack **\$32.98**



#180808pk **Cefazolin Sodium**
1gm, 10mL 25/pack **\$43.15**



#180853pk **Dopamine HCl**
200mg 25/pack **\$36.60**



#180903pk **Cefprozil**
75mL 6/pack **\$24.60**



#180854pk **Doxorubicin**
50mg/25mL 16/pack **\$34.25**



#180846pk **Ceftazidime Powder**
1g 25/pack **\$43.15**



























#180815pk **Epinephrine 1:1000**
1mL vial 25/pack **\$34.20**

VIALS

	#180855pk	Enoxaparin Na 300mg/3mL 16/pack	\$34.25		#180831pk	GLO Vial, Liquid 5mL 25/pack	\$36.60
	#180857pk	Flu 5mL 25/pack	\$39.50		#180832pk	GLO Vial, Liquid 10mL 25/pack	\$43.15
	#180860pk	Flumazenil 1mg/10mL 25/pack	\$43.15		#180833pk	GLO Vial, Liquid 1g 25/pack	\$43.15
	#180856pk	Fluorescein Sodium 10% 5mL 25/pack	\$36.60		#180866pk	Glucagon Powder 1mg 25/pack	\$43.15
	#180858pk	Fluorouracil 500mg/10mL 16/pack	\$32.98		#180867pk	Hep B 0.5mL 25/pack	\$37.15
	#180859pk	Fluphenazine Decanoate 25mg/mL 25/pack	\$36.60		#180834pk	Heparin Flush 25/pack	\$37.50
	#180861pk	Furosemide 20mg/2mL 25/pack	\$34.20		#180835pk	Heparin Pak 5mL and 10mL 36/pack	\$54.00
	#180862pk	Furosemide 40mg/4mL 25/pack	\$36.60		#180816pk	Heparin 1,000 U/mL 25/pack	\$37.50
	#180863pk	Ganciclovir 500mg/10mL 25/pack	\$43.15		#180817pk	Heparin 10,000 U/mL 25/pack	\$37.50
	#180864pk	Gemcitabine 1gm/30mL 16/pack	\$34.25		#180868pk	Idarubicin 20mg/30mL 16/pack	\$34.25
	#180865pk	Gentamicin 40mg/mL 16/pack	\$32.98		#180869pk	Ifosfamide 1gm, 20mL 16/pack	\$32.98
	#180830pk	GLO Vial, Liquid 2mL 25/pack	\$34.20		#180811pk	Insulin (Regular) 1000 units/10mL 25/pack	\$45.54























Practice Meds

VIALS

	#180870pk	Iodixanol 50mL	9/pack	\$25.98		#180814pk	Lorazepam Injection 2mg/mL	25/pack	\$34.20
	#180871pk	Iohexol 300mg/mL	9/pack	\$25.98		#180875pk	Magnesium Sulfate 50% 2mL	25/pack	\$34.20
	#180872pk	Iopamidol 61% 50mL	9/pack	\$25.98		#180876pk	Magnesium Sulfate 50% 1gm/2mL	16/pack	\$32.98
	#180873pk	Iothalamate Meglumine 43% 50mL	9/pack	\$25.98		#180877pk	Midazolam 5mg/mL	25/pack	\$34.20
	#180874pk	Ketorolac Tromethamine 15mg/mL	25/pack	\$34.20		#180878pk	Midazolam 10mg/10mL	25/pack	\$43.15
	#180822pk	Liquid 2mL	25/pack	\$32.50		#180812pk	Morphine Sulfate Injection 5mg/mL	25/pack	\$36.60
	#180823pk	Liquid 3mL	25/pack	\$36.60		#180880pk	Multitrace-5 10mL	25/pack	\$43.15
	#180824pk	Liquid 5mL	25/pack	\$36.60		#180882pk	Nitroglycerin 50mg/10mL	25/pack	\$43.15
	#180825pk	Liquid 10mL	25/pack	\$43.15		#180883pk	Norepinephrine Bitartrate 4mg/4mL	25/pack	\$36.60
	#180826pk	Liquid 20mL	16/pack	\$32.98		#180884pk	Ondansetron 2mg/mL	25/pack	\$34.20
	#180827pk	Liquid 30mL	16/pack	\$34.25		#180885pk	Paclitaxel 6mg/mL	9/pack	\$25.98
	#180828pk	Liquid 50mL	9/pack	\$25.98		#180886pk	Palivizumab 100mg/mL	25/pack	\$32.50

Practice Meds

VIALS

	#180887pk	Pantoprazole Sodium 40mg 25/pack	\$43.15		#180896pk	Sodium Acetate 200mEq 16/pack	\$32.98
	#180888pk	Penicillin G Potassium 20,000,000 units 6/pack	\$36.00		#180897pk	Sodium Bicarbonate 8.4% 50mEq 9/pack	\$25.98
	#180889pk	Phenylephrine 4mg/mL 25/pack	\$34.20		#180898pk	Sodium Phosphates 5mL 25/pack	\$36.60
	#180890pk	Phenylephrine 10mg/mL 25/pack	\$34.20		#180899pk	Streptozocin 1gm/30mL 16/pack	\$34.25
	#180891pk	Potassium Chloride 20mEq 25/pack	\$43.15		#181701pk	Succinylcholine 20mg/mL 16/pack	\$32.98
	#180807pk	Powder-C 25/pack	\$43.15		#181702pk	TB Skin Test 0.5mL 25/pack	\$32.50
	#180819pk	Powder-Y 25/pack	\$43.15		#181703pk	Thiamine HCl 100mg/mL 25/pack	\$34.20
	#180892pk	Procainamide HCl 100mg/mL 25/pack	\$43.15		#181704pk	Topotecan 4mg 10mL 25/pack	\$43.15
	#180813pk	Promethazine HCl Injection 25mg/mL, 1mL 25/pack	\$34.20		#181705pk	Vancomycin Powder 20mL vial 16/pack	\$32.98
	#180893pk	Propofol Emulsion 500mg/50mL 9/pack	\$25.98		#181706pk	Vasopressin 20 units/1mL 25/pack	\$34.20
	#180894pk	Propofol Emulsion 1gm/100mL 9/pack	\$39.00		#181707pk	Verapamil HCL 25/pack	\$34.20
	#180895pk	Ranitidine 25mg/mL, 2mL 25/pack	\$34.20				

Carts

Defibrillators
ECGs

Diagnostics

Gloves

Hospital
Beds

Infusion

Labels

Manikins
Simulators

Media

Monitors

New
Products

Patient
Care

Patient
Room

Practice
Meds

PYXIS®

Respiratory

Student
Kits

Syringes

Training
Headwall
Units

Practice Meds

VIAL PACKS/TRAINING INSULIN PACKS

POWDER C FOR DUMMIES

(Nonstick)

- Hands-on training with a vial for reconstitution
- Easy clean up when used with the manikins IV lines
- Will not become sticky when dried



#180836pk 25/pack **\$45.00**

MEASLES, MUMPS, & RUBELLA PAK

- (10) Vials of Measles, Mumps, and Rubella powder vials for reconstitution
- (10) Vials of the diluent needed to reconstitute the powder



#180703 20/pack **\$32.95**

HEPARIN PAK

5mL and 10mL



#180835 36/pack **\$64.20**

MULTI-VITAMIN DUAL PAK

- 5mL
- Mix together vials



#180881 20/pack **\$32.95**

LIQUID VARIETY PAK

(10) 10mL, (10) 5mL, (5) 2mL



#180829 25/pack **\$38.50**

Need a Custom Product Developed?

Contact Us 1-855-MED-SHIP



G.



H.



I.



I. 9 of each

TRAINING INSULIN PACKS

A #180301pk **Insulin 70/30** 25/pack **\$37.50**

B #180302pk **Lantus** 25/pack **\$37.50**

C #180306pk **Insulin** 25/pack **\$37.50**

D #180307pk **Lispro** 25/pack **\$37.50**

E #180308pk **NPH** 25/pack **\$37.50**

F #180309 **70/30, Lantus Pak** 36/pack **\$54.00**

G #180310 **Humulin R/N Pak** 36/pack **\$54.00**

H #180311 **NPH/Regular Pak** 36/pack **\$54.00**

I #180312 **Variety Pak** 36/pack **\$64.20**

Practice Meds

AMPULES



A. D. F. H. L. P. S. V.

TRAINING AMPULES-25-PACK

A	#180105pk	Ampule 1mL	\$18.15	M	#180114pk	Hydromorphone HCl 10mg/mL, 1mL	\$18.15
B	#180101pk	Ampules 2mL	\$18.15	N	#108104pk	Hydromorphone HCL 1mg/mL, 1mL	\$18.15
C	#180102pk	Ampules 5mL	\$22.58	O	#180115pk	Isoproterenol 1mg/5mL, 5mL	\$22.58
D	#180107pk	Ampule 10mL	\$27.70	P	#180116pk	Meperidine HCl Injection 75mg/mL, 1mL	\$18.15
E	#180106pk	Ampule Tinted 1mL	\$18.15	Q	#180117pk	Meperidine HCl 100mg/mL, 1mL	\$18.15
F	#180103pk	Ampules Tinted 2mL	\$19.98	R	#180118pk	Metoprolol Tartrate 5mg/5mL, 5mL	\$22.58
G	#180108pk	Glo Ampule Liquid 5mL	\$22.58	S	#180119pk	Morphine Sulfate Injection CII 10mg/mL, 1mL	\$18.15
H	#180109pk	Busulfan 6mg/mL, 10mL	\$27.70	T	#180120pk	Naloxone .4mg/mL, 1mL	\$18.15
I	#180110pk	Digoxin 2mL	\$18.15	U	#180121pk	Phytonadione Injectable Emulsion 1mg/.5mL, 1mL	\$18.15
J	#180111pk	Dimenhydrinate HCl 50mg/mL, 1mL	\$18.15	V	#180122pk	Phytonadione Injectable Emulsion 10mg/mL, 1mL	\$18.15
K	#180112pk	Epinephrine 1:1000 1mg/mL	\$18.15	W	#180123pk	Teniposide 5mL	\$22.58
L	#180113pk	Fentanyl Citrate Injection 250mcg/5mL (50mcg/mL)	\$22.58	X	#180124pk	Ampule Variety Pak (5 each) 2mL Clear, 2mL Tinted, 5mL Clear, 1mL Tinted, (5) 1mL Clear	\$24.95

Carts

Defibrillators
ECGs

Diagnostics

Gloves

Hospital
Beds

Infusion

Labels

Manikins
Simulators

Media

Monitors

New
Products

Patient
Care

Patient
Room

Practice
Meds

PYXIS®

Respiratory

Student
Kits

Syringes

Training
Headwall
Units

Practice Meds

TRAINING LIQUIDS



A.



B.



C.



D.



E.



F.



G.



H.



I.



J.



K.



L.



M.



N.



O.

A #180407pk **Acetaminophen Oral Suspension (Liquid)** 160mg/5mL 5/pack **\$14.95**

B #180408 **Acetaminophen Oral Suspension (Cherry)** 80mg/2.5mL, 4 oz. 1/each **\$8.95**

C #180409 **Albuterol Solution** 2mg/5mL, 473mL 1/each **\$29.28**

D #180405pk **Aluminum Hydroxide Antacid (Liquid)** 200mg/5mL 5/pack **\$14.95**

E #180901pk **Amox/Pot. Clavunate** 100mL 6/pack **\$24.60**

F #180410 **Dextromethorphan HBr** 15mg/5mL, 118mL 1/each **\$10.98**

G #180415 **Docusate Sodium Syrup** 50mg/5mL, 473mL 1/each **\$29.28**

H #180412 **Lactulose Solution** 10gm/15mL, 473mL 1/each **\$29.28**

I #180419 **Lidocaine 2% Oral Viscous** 100mL 1/each **\$10.98**

J #180413 **Lidocaine Spray 10%** 60mL 1/each **\$16.99**

K #180414 **Nystatin** 100,000 u/mL, 473mL 1/each **\$29.28**



















L #180406pk **Prednisone Oral Solution (Liquid)** 160mg/5mL 5/pack **\$14.95**

M #180416 **Prednisolone** 15mg/5mL, 473mL 1/each **\$29.28**

N #180417 **Promethazine VC Syrup** 15mg/5mL, 473mL 1/each **\$29.28**

O #180418 **SMZ/TMP Suspension** 473mL 1/each **\$29.28**

MISC

	#181708bx	Albuterol Sulfate & Ipratropium Bromide Nebulizer		\$32.99		#181710bx	Levalbuterol HCl Nebulizer		\$32.99		
			30/box					30/box			
	#181501pk	Cream	30g	5/pack	\$41.82		#181507pk	Lotion	30mL	5/pack	\$47.22
	#181502pk	Cream	60g	5/pack	\$45.18		#181508pk	Nasal Spray	30mL	5/pack	\$29.64
	#181503pk	Dextrose Gel 40%	30mg	5/pack	\$41.82		#181509pk	Ointment	30mg	5/pack	\$41.82
	#181515	EpiPen		1/each	\$12.95		#181510pk	Ointment	60mg	5/pack	\$45.18
	#181504pk	Eye Ointment	10mL	5/pack	\$37.98		#181511pk	Ophthalmic Solution Timolol 0.5%	15mL	5/pack	\$23.28
	#181506pk	Gel	30mg	5/pack	\$41.82		#181512pk	Otic Solution	10mL	5/pack	\$21.18
	#181505pk	Gentamicin Sulfate 0.3%	10mL	5/pack	\$21.18		#181513pk	Suppositories Adult		12/pack	\$24.95
	#181709bx	Ipratropium Bromide 0.02% Nebulizer			\$32.99						
				30/box							

Practice Meds

VARIETY PACKS



TABLET VARIETY PAK A

- This tablet variety pak contains 19 unique bottles of 100-count tablets

#181804	19 bottles	\$383.98
---------	------------	-----------------



TABLET VARIETY PAK B

- This variety pak contains 9 unique 100-count bottles and 10 unique 500-count bottles of tablets

#181805	19 bottles	\$950.38
---------	------------	-----------------



TABLET VARIETY PAK C

- This tablet variety pak contains 19 unique bottles of 500-count tablets

#181806	19 bottles	\$1,631.98
---------	------------	-------------------

LONG TERM CARE CARD

- Plain card
- No label
- Capsules



#180501	31/pack	\$5.25
---------	---------	---------------



TABLET VARIETY PAK D

50-count pack of each of the 19 different tablets

Enalapril 5mg	Hydrochlorothiazide 25mg
Atenolol 50mg	Sodium Flotide 0.5mg
Folic Acid 1mg	Lisinopril 2.5mg
Isosorbide Dinitrate 10mg	Metformin 500mg
Prednisone 5mg	Glyburide 3mg
Captopril 12.5mg	Glipizide 5mg
Furosemide 20mg	Enalapril Maleate 2.5mg
Atenolol 100mg	Furosemide 40mg
Amitriptyline HCl 10mg	Fluoxetine 10mg
Meloxicam 15mg	

#181808	Variety Packs	\$273.75
---------	---------------	-----------------

NEW PRODUCTS

See pages 128–133



TABLET SAMPLE PAK

Includes:

- (10) **Unit Dose Furosemide** 20mg
- (10) **Atenolol** 50mg
- (10) **Metformin** 500mg
- (10) **Folic Acid** 1mg
- (10) **Hydrochlorothiazide** 25mg
- (10) **Prednisone** 5mg
- (10) **Glipizide** 5mg
- (10) **Lisinopril** 2.5mg
- (10) **Fluoxetine** 10mg

#181807	50 Unit Dose Tablets	\$19.95
---------	----------------------	----------------

VARIETY PACKS



CAPSULE VARIETY PAK A

- This kit includes a variety of 20 unique 100-count bottles of capsules

#181801 20 bottles **\$383.98**



CAPSULE VARIETY PAK B

- (10) unique bottles of 100-count capsules
- (10) unique bottles of 500-count capsules

#181802 20 bottles **\$950.38**



CAPSULE VARIETY PAK C

- 20 unique 500-count bottles of capsules

#181803 20 bottles **\$1,631.98**



LIQUID VARIETY PAK (Color)

- Red, Yellow, Blue, Green

#181811 4/pack **\$4.98**

CAPSULE VARIETY PAK D

50-count pack of each of the 20 different capsules

Amoxicillin 500mg	Tetracycline 250mg	Notriptyline HCl 180mg
Piroxicam 20mg	Acyclovir 250mg	Terazosin 5mg
Minocycline 100mg	Labetalol 100mg	Fexofenadine 60mg
Disopyramide 25mg	Rifampin 300mg	Verapamil HCl 180mg
Prazosin HCl 5mg	Cephalexin 500mg	Diltiazem 120mg
Clomipramine 25mg	Phenytoin 30mg	Procainamide 250mg
Clindamycin 150mg	Chlordiazepoxide 5mg	

#181809 Variety Pack **\$288.15**



CAPSULE SAMPLE PAK

Training Capsules	(10) Labetalol 100mg
(10) Amoxicillin 500mg	(10) Rifampin 300mg
(10) Tetracycline 250mg	(10) Cephalexin 500mg
(10) Verapamil HCl 180mg	(10) Notriptyline HCl 180mg
(10) Diltiazem 120mg	(10) Piroxicam 20mg
	(10) Phenytoin 30mg

#181810 50 Unit Dose Tablets **\$19.95**



TRAINING VARIETY PAK

- (10) **Furosemide Unit Dose** 20mg
- (1) Topical cream 30g tube
- (1) Topical ointment 30g tube
- (10) Ampules 5mL
- (1) **Amoxicillin** Antibiotic Suspension
- (1) **Amoxicillin/Potassium Clavunate** Antibiotic Suspension
- (5) Vials 10mL
- (3) Vials **Powder-C**
- (3) Vials **Powder-Y**
- (3) Vials 5mL

#181813 Variety Pack **\$49.30**

Practice Meds

KITS



CRASH CART KIT

Training Capsules

Atropine Sulfate Injection

1mg/mL (1-1mL vial)

Adenosine Injection

6mg/2mL or 3mg/mL (2-2mL vials)

Calcium Chloride Injection 10%

(100mg/mL) (1-10mL vial)

Dexamethasone Sodium Phosphate Injection

4mg/mL (1-1mL vial)

Diltiazem HCl

25mg/5mL or 5mg/mL (3-5mL vials)

Diphenhydramine HCl Injection

50mg/mL HIGH POTENCY (1-1mL vial)

Flumazenil Injection

1mg/10mL or 0.1mg/mL (1-10mL vial)

Vasopressin Injection Synthetic

20units/1mL (2-1mL vials)

50% Dextrose Injection

25g 0.5g/mL (1-50mL vial)

Amiodarone HCl Injection

150mg/3mL or 50mg/mL

(2-5mL amber vials)

Nitroglycerin Injection

50mg/10mL or 5mg/mL

(1-10mL amber vial)

8.4% Sodium Bicarbonate Injection

50mEq or 1mEq/mL (1-50mL vial)

Dopamine HCl Injection

200mg or 40mg/mL (1-5mL vial)

Furosemide Injection

20mg/2mL or 10mg/mL

(2-2mL amber vials)

Magnesium Sulfate Injection 50%

4mEq Mg⁺⁺/mL (1-20mL vial)

Phenylephrine Injection

10mg/mL (1-1mL vial)

Epinephrine Injection 1:1000

1mg/mL (4-1mL ampules)

Epinephrine 1:10,000

0.1mg/mL (2) pre-filled syringes

Naloxone

0.4mg/mL (1) pre-filled syringe

Digoxin

0.5mg/2mL or .25mg/mL

(1-2mL ampule)

NaCl 0.9% IV Bag

(2-500mL IV bags)

#181814

Crash Cart Kit

\$67.50



AMBULANCE EMERGENCY TRAINING KIT

(5) Adenosine Injection Vials

6mg/2mL

(2) Diphenhydramine HCl Injection

50mg/mL High Potency

(2) Verapamil HCl Injection Vials

5mg 25mg/mL

(2) Dexamthasone Sodium Phosphate Injection Vials

4mg/mL

(1) Epinephrine 1:1000 Vials

2mL

(1) Glucagon Powder Vials

1mg (1 unit)

(2) Furosemide Vials

40mg/4mL

(2) Promethazine HCl Vials

25mg/mL

(2) Thiamine HCl Vials

100mg/mL

(2) Ketorolac Tromethamine Vials

15mg/mL

(3) Ondansetron Vials

2mg/mL

(2) Atropine Sulfate Prefilled Syringes

0.1mg/mL 10mL

(2) Calcium Chloride Prefilled Syringes

100mg/mL 10mL

(2) Prefilled Syringes

D50 50mL

(6) Epinephrine Injection 1:1000 Ampules

1mg/mL

(1) Furosemide Vial

100mg/10mL

(2) Magensium Sulfate 50% Vial

2mL

(1) Dextrose Gel 40% Gel

30g tube

(2) Lidocaine HCl 2% Prefilled Syringes

20mg/mL (5mL)

(2) Sodium Bicarbonate 8.4% (Adult) Prefilled Syringes

10mL

(2) Sodium Bicarbonate 8.2% (Infant) Prefilled Syringes

0.4mg/mL (1mL)

(4) Naloxone Prefilled Syringes

0.4mg/mL (1mL)

(1) Acetaminophen Suspension Liq.

80mg/2.5mL Cherry 4oz

Tablets, Acetylsalicylic Acid (ASA)

81mg Chewable 100-count bottle

Tablets, Nitroglycerin

0.4mg 100-count bottle

#181812

Training Kit

\$164.99



NEED A QUOTE?

MedicalShipment.com makes it easy to create a quote online!

1. Find supplies and equipment online
2. Click 'Add to Quote' to save an item
3. Fill in your shipping details and receive a quote instantly!
(Shipping not included in quote)

It's as simple as that!

Browse our catalog, then go to www.medicalshipment.com



Join Us
On Facebook

facebook.com/medicalshipment

Pyxis Medstation® 4000

LEADING AUTOMATED DISPENSING SYSTEM IN THE HOSPITAL MARKET

The Pyxis Medstation® 4000 is the state-of-the-art automated medication dispensing system used by most hospitals.

Medical Shipment is proud to offer this training system to the education marketplace.

Trusted by hospitals across the country—and now available to nursing and pharmacy training programs.

The Pyxis Medstation® 4000 Training System helps students learn to streamline the medication management process, and to safely and efficiently dispense a full range of medications.

You can now put Pyxis to work in your training program, complete with **hassle-free delivery, installation and ongoing manufacturer support.**

Benefits include:

- Reduced time to first dose
- Improved workflow
- Reduced adverse drug events
- Reduced missed doses
- Lower costs than unit-dose process

This **comprehensive package** includes:

- Modular CUBIE® System
- Starter kit of practice meds
- Demo drug library software
- Online and on-site training
- Live telephone support
- One year service agreement with the option of an extended service agreement
- **FREE shipping**

Safe and efficient medication management

Barcode scanning for accurate dispensing

Active safety alerts for high-risk medications

Trusted by hospitals across the country



22.8" W x 55" H x 27" D

ADD TO QUOTE

Choose your items on our website, click **"ADD TO QUOTE"**, enter your shipping details, and we email your quote instantly!

Includes features that prevent loading the wrong medication, active alerts that provide an added safety precaution for high-risk medications, Demo Database Software (with 930+ preloaded formularies and 16 profiled patients), and the modular CUBIE® system that helps students get the right medication to the right patient at the right time.

PREMIUM PYXIS® PACKAGE



A.



B.



C.

PREMIUM PYXIS® PACKAGE

A. PYXIS® MEDSTATION 4000

The Pyxis Medstation® 4000 is the state-of-the-art automated medication dispensing system used by most hospitals—and Medical Shipment is proud to offer this training system **exclusively** to the education marketplace.

Complete package includes:

- Modular CUBIE® System
- Starter kit of practice meds
- Online and on-site training
- Live telephone support
- One year service agreement with the option of an extended service agreement

#150102

B. SINGLE-COLUMN, FOUR-DOOR AUXILIARY UNIT

Store large quantities of items with reliable, high-level security. Provides secure, yet easy access for students with *Touch-to-Take* technology, a biolD fingerprint system that confirms user identity with one touch.

78.8" H x 30" W x 27.5" D

#150103

EVERY PYXIS OPTION

Includes:

- **FREE** installation
- **FREE** shipping
- **ONE** year service agreement

C. PYXIS® CONSOLE AND CABINET

Customizable information can be entered on the Pyxis MedStation 4000 (enter specific names and information to match textbooks or teaching materials). The Console can connect wirelessly with multiple Pyxis MedStation 4000s. The Console allows educators to enter customized patients, users, medications, medication orders, and reporting capability. The Console includes cabinet and monitor.

49" H x 30" W x 24" D

#150105

#150109	Premium Package (Includes A, B, C) Save over \$1800 with this package!	\$49,999.00
#150104	Extended One Year Service Agreement for Pyxis® MedStation 4000, per year	\$1,099.00
#150110	Extended One Year Service Agreement for Auxiliary Unit, per year	\$749.00
#150106	Extended One Year Service Agreement for Console and Cabinet, per year	\$1,099.00

Pyxis Medstation® 4000 Options



Pyxis®
Medstation
4000

PYXIS® MEDSTATION 4000

MedStation comes with On-site Training, Practice Med Starter Kit, and Demo Database. Non-customizable information on the MedStation (includes Demo Database in generic format, 930+ preloaded formularies and 16 profiled patients).

FREE inside installation, one year service agreement and **FREE** shipping.

#150102	Pyxis 4000	\$22,899.00
#150104	Extended One Year Service Agreement, per year	\$1,099.00



Single-Column
Four-Door
Auxiliary Unit

SINGLE-COLUMN, FOUR-DOOR AUXILIARY UNIT

Store large quantities of items with reliable, high-level security. Provides secure, yet easy access for students with *Touch-to-Take* technology and a bioID fingerprint system that confirms user identity with one touch. 78.8" H x 30" W x 27.5" D

FREE inside installation, one year service agreement and **FREE** shipping.

#150103	Auxiliary Unit	\$8,999.00
#150110	Extended One Year Service Agreement, per year	\$749.00



Console
and Cabinet

PYXIS® CONSOLE AND CABINET

Customizable information can be entered into Console to display on Pyxis MedStation 4000 (enter specific names and information to match textbooks or teaching materials). The Console can connect wirelessly with multiple Pyxis MedStation 4000's. The Console allows educators to enter customized patients, users, medications, medication orders, and reporting capability. The Console includes cabinet and monitor. Measures 49" H x 30" W x 24" D.

FREE inside installation, one year service agreement and **FREE** shipping.

#150105	Console	\$19,999.00
#150106	Extended One Year Service Agreement, per year	\$1,099.00

ADDITIONAL PYXIS® OPTIONS

PYXIS MEDSTATION 4000 2-DRAWER

Pyxis MedStation System is a leading automated dispensing system supporting decentralized medication management. Barcode scanning to help ensure accurate medication dispensing, features to prevent loading of the wrong medication and active alerts to provide an added safety precaution for high risk medications are just a few of the ways the Pyxis MedStation system can help your facility support safe and efficient medication management.

Includes:

- **FREE** inside installation
- **FREE** shipping included
- 2 Drawers
- Barcode scanner
- Biometric identification
- Demo database software
- Starter kit of practice meds
- One year service agreement

Non customizable information on station (information on demo database is in generic format 930+ with pre-loaded formularies and 16 profiled patients).

#150107	Pyxis MedStation 4000 2-Drawer	\$19,500.00
#150113	Extended Service Agreement	\$1,099.00



PYXIS MEDSTATION 4000 WORKSTATION

Includes:

- Monitor
- NUC
- Keyboard
- One year service agreement

#150111	Workstation	\$12,500.00
#150112	Extended Service Agreement	\$1,099.00



Extended Service Agreements

#150104	Extended One Year Service Agreement for Pyxis® 4 Drawer, per year	\$1,099.00
#150110	Extended One Year Service Agreement for Auxiliary Unit, per year	\$749.00
#150106	Extended One Year Service Agreement for Console and Cabinet, per year	\$1,099.00
#150112	Extended Service Agreement for Medstation 4000 Workstation, per year	\$1,099.00
#150113	Extended One Year Service Agreement for Pyxis Medstation 4000, 2 Drawer, per year	\$1,099.00

Respiratory

MASKS, CPR



FACE MASK

- Soft, clear finish for greater patient comfort
- Elongated (under the chin) design
- Features an adjustable nose clip and elastic braid

#160101	Adult, High Concentration, Non-Rebreather	1/each	\$1.95
#160103	Pediatric, High Concentration, Non-Rebreather	1/each	\$1.95
#160102	Adult, Medium Concentration	1/each	\$1.05



ELONGATED AEROSOL MASK (Adult)

- Standard (under the lip) and elongated (under the chin) sizes
- Adjustable nose clip and elastic braid
- Fits standard oxygen tubing connection

#160110	Elongated Aerosol Mask	1/each	\$0.67
---------	------------------------	--------	---------------



LATEX-FREE RESUSCITATION DEVICES

- Initiate resuscitation and life support during cardiopulmonary arrest
- Includes 10' oxygen tubing
- Feature easy-grip texture and clear housing for easy view of patient valve

#160107	Neonate	1/each	\$27.50
#160108	Pediatric	1/each	\$28.50
#160109	Adult	1/each	\$23.25



POLYBAG WITH FACE SHIELD

- One-way valve eliminates blow back to caregiver
- Includes detailed instructions and soft case features a swivel-eye snap hook

#160112	Polybag with Face Shield	1/each	\$1.75
#160113	Soft Case with Face Shield	1/each	\$2.99



ADSAFE™ LATEX-FREE CPR POCKET RESUSCITATOR

- For adults and infants/children (inverted)
- Includes pocket storage case

#160104	AdSafe Resuscitator	1/each	\$8.50
#160105	Mask only	1/each	\$7.65
#160106	Valve only	1/each	\$2.75

ACCESSORIES/TRACHEOSTOMY

BUBBLE HUMIDIFIER

- Available in 400 cc/mL water bottles
- Maximum and minimum water level markings are clearly defined

#160420	Bubble Humidifier	1/each	\$2.25
---------	-------------------	--------	---------------



STANDARD NASAL CANNULA (Adult)

- Lightweight and fits easily over the ear

#160116	Standard Nasal Cannula	1/each	\$0.84
---------	------------------------	--------	---------------



TRACHEOSTOMY

7' OXYGEN TUBING

- Smooth internal bore and star-shaped interior cross section

#160111	Oxygen Tubing	1/each	\$0.55
---------	---------------	--------	---------------



TRACHEOSTOMY MASK (Adult)

- Adjustable elastic braids
- Connectors accept standard 22mm aerosol tubing and has a 5.4mm adaptor

#160410	Tracheostomy Mask	1/each	\$1.25
---------	-------------------	--------	---------------



SHILEY LATEX-FREE TRACHEOSTOMY ONLY (with Disposable Inner Cannula)

- Provides the right fit to maintain airway patency, for long-term ventilation support
- 15mm cannula features snap-lock connector

#160408	Shiley Trach Only	1/each	\$56.99
#160409	Additional Disposable Inner Cannula (15mm)	1/each	\$7.90



Posey CUFFLATOR

- Deflates and inflates high-volume, low-pressure endotracheal or tracheal cuffs.
- Air vent button and inflator bulb adjusts cuff pressure quickly and easily
- Gauge shows recommended pressure range in cm H₂O

#160407	Posey Cufflator	1/each	\$399.00
---------	-----------------	--------	-----------------



Respiratory

TRACHEOSTOMY



TRACHEOSTOMY *continued*

TRACHEOSTOMY CARE TRAYS (Sterile)

- Features 3 compartments and includes:
 - (1) Roll 30" twill tape; (2) 6" Cotton-tipped applicators; (1) Trachea tube brush;
 - (1) Pre-cut gauze tracheostomy dressing; (4) 4" x 4" Gauze sponges; (1) Pair of sterile powder-free, vinyl exam gloves; (2) Pipe cleaners

#160401	Tracheostomy Care Tray	1/each	\$2.75
#160402	Tracheostomy Care Tray with 14Fr Catheter	1/each	\$3.60
#160403	Tracheostomy Care Tray with Saline	1/each	\$4.75

YANKAUER LATEX-FREE SUCTION HANDLE

- Sterile suction tool for removing particulates and viscous material

#160418	Vented	1/each	\$2.25
#160419	Non Vented	1/each	\$2.49

TRACHEOSTOMY TUBE HOLDER (Adult or Pediatric)

- Provides secure positioning and minimizes the movement of the tracheostomy tube

#160404	Adult (19" Length)	1/each	\$2.99
#160405	Pediatric (9" Length)	1/each	\$2.99

Posey SECURE TIES

- Recommended for patients with tracheostomy tubes
- Adjustable sizing

#160406bx	Adult (19" Length)	1/each	\$3.99
-----------	--------------------	--------	---------------

**Committed to Providing
Quality Products**



SUCTION CATHETERS, PEAKFLOW

SUCTION CATHETER KIT (Sterile)

- Kit contains: pop-up solution cup, suction catheter (with control valve), and (2) sterile gloves, coil packed

#160306	6Fr	Pediatric	1/each	\$0.99
#160307	8Fr	Pediatric	1/each	\$0.99
#160301	10Fr		1/each	\$0.99
#160302	12Fr		1/each	\$0.99
#160303	14Fr		1/each	\$0.99
#160304	16Fr		1/each	\$0.99
#160305	18Fr		1/each	\$0.99



SUCTION CATHETER (Sterile)

- Includes control valve
- Coil packed

#160313	6Fr	Pediatric	1/each	\$0.75
#160314	8Fr	Pediatric	1/each	\$0.75
#160308	10Fr		1/each	\$0.75
#160309	12Fr		1/each	\$0.75
#160310	14Fr		1/each	\$0.75
#160311	16Fr		1/each	\$0.75
#160312	18Fr		1/each	\$0.75



COACH 2® INCENTIVE SPIROMETER

- One-way valve ensures patients inhale, rather than exhale into the unit
- Includes an O₂ connection for supplemental oxygen, handle and bedrail holder, flexible tubing and instructions

#160503	Incentive Spirometer	1/each	\$4.25
---------	----------------------	--------	---------------



SPIROFLOW PEAK FLOW

- Compact design; easy to clean and sanitize

#160501	Pediatric, < 370 liters/min	1/each	\$14.75
#160502	Adult, 50–800 liters/min	1/each	\$14.75



Pediatric

Adult

Respiratory

PULSE OXIMETER



FINGERTIP PULSE OXIMETER

- Reads SpO₂ and pulse (SpO₂ ±2%/HR ±5%BPM)
- Features two display modes (including bright red LED)
- Includes carry lanyard, (2) "AAA" batteries, and instruction booklet
- One year limited warranty

#160203	Fingertip Pulse Oximeter	1/each	\$84.99
---------	--------------------------	--------	----------------



DIGITAL FINGERTIP PULSE OXIMETER

- A portable pulse oximeter that provides spot readings of SpO₂ and heart rate

#160205	Digital Fingertip Pulse Oximeter	1/each	\$99.00
---------	----------------------------------	--------	----------------



DIGIT™ FINGER PULSE OXIMETER

- A portable pulse oximeter that provides spot readings of SpO₂ and heart rate

#160201	Digit Finger Pulse Oximeter	1/each	\$324.00
---------	-----------------------------	--------	-----------------



PULSE OXIMETER (with Protective Cover)

- Data transfers to PC for storage and review
- Features FDA approved LCD display real-time clock; display backlight; auto power-off
- SpO₂ and pulse rate; long-life battery (AA or Ni-MH)
- Specify Blue, Gray Or Green

#160204	Pulse Oximeter	1/each	\$349.00
---------	----------------	--------	-----------------



BCI HANDHELD PULSE OXIMETER

- Neonate through adult
- Bright, easy-to-read LED numerals; quantitative pulse strength bar on screen
- Stores data for 99 patients
- Auto shut-off
- Uses (3) "C" batteries

#160206	BCI Handheld Pulse Oximeter	1/each	\$499.00
---------	-----------------------------	--------	-----------------

AIRWAYS

MILLER BLADE

- Stainless steel construction with satin non-glare finish

#160601	Small Premie	1/each	\$31.99
#160602	Premie	1/each	\$31.99
#160603	Infant	1/each	\$31.99
#160604	Child	1/each	\$31.99
#160605	Adult	1/each	\$31.99
#160606	Large Adult	1/each	\$31.99

BLADE SETS

- Four blades #1, 2, 3, 4 and (2) handles "C" and "AA" batteries in foam-lined fitted case

#160616	Small Premie	1/each	\$199.00
#160615	Premie	1/each	\$175.00

MACINTOSH BLADE

- Stainless steel construction with satin non-glare finish

#160607	Premie	1/each	\$29.99
#160608	Infant	1/each	\$29.99
#160609	Child	1/each	\$29.99
#160610	Adult	1/each	\$29.99
#160611	Large Adult	1/each	\$29.99

BLADE BATTERY HANDLES

- Satin handles with a knurled finish for a positive grip
- Available in traditional "C", "AA", and stubby "AA"
- Batteries not included

#160613	Small	1/each	\$31.99
#160612	Medium	1/each	\$31.99
#160614	Stubby	1/each	\$31.99

ORAL AIRWAYS BERMAN TYPE

- Oral airways are made of polypropylene (PP)
- Disposable
- Reinforced bite block prevents collapse of airway

#160411	Infant	1/each	\$0.75
#160412	Child	1/each	\$0.75
#160413	Small	1/each	\$0.75
#160421	Medium	1/each	\$0.75
#160415	Large	1/each	\$0.75
#160416	XLarge	1/each	\$0.75
#160417	Oral Airways Berman Type, Kit	1/each	\$5.99



Student Kits

FULLY CUSTOMIZED

TOP 5 REASONS...

Why Our Nurse Kits Are The Best!



- 1 Our kits are **100% customizable**. Choose the style and shape of your bag and everything you want in it.

- 2 Select the **products and brands you want**. Create a bag that's customized to your specific needs. (Other companies only allow you to choose from one particular brand).

- 3 Our unique and fully **customized supply lists** allow students to keep track of and account for each and every item. They are automatically included in each bag.



- 4 Our **personalized student ID tags** help distinguish which bags belong to which students, eliminating mistakes before they can occur.

- 5 Our high quality bags can be further customized to feature your **school's logo**, adding that important sense of loyalty to your specialized training programs.



To learn more visit us at MedicalShipment.com or call us (847) 253-3000

FULLY CUSTOMIZED

Our Kits Are Fully Customizable

3 Easy Steps

1 SELECT TOTE, STYLE, & COLOR *(Logo Included)*

Select one of our totes or send us an image of one that you prefer



2 CUSTOMIZE THE KIT CONTENTS

Provide us with your current Kit List (or)
Contact us for **Personalized** assistance in
building your ideal kit.

Call us for a quote

1-847-253-3000

info@medicalshipment.com

3 QUOTE

Receive a **Custom Quote** for your
approval and **Place** your order.

Student Kits

PRE-MADE KITS

NURSING SUPPLY KIT

Includes (1) of each:

- Injection pad with strap
- Alcohol prep pads, medium (*sterile*)
- Cloth surgical tape 1" x 10 yards
- ViewGuard transparent dressing 4" x 4-3/4"
- Elastic bandages, latex free, 3" x 5'
- Tongue depressors sterile 5-1/2" & 6"
- Drain sponges, 4" x 4", 6 ply, 2s (*sterile*)
- Dressing change tray with Tegaderm (*sterile*)
- Cleansing enema set, bag pack
- Suction catheters, 12Fr
- Gait belt
- Foley catheter, latex, 5cc, with non-sterile swab, 14Fr
- Irrigation tray, 60cc piston syringe
- Erythromycin 250mg, training tablets
- Training insulin, NPH
- Training vial, 2g for reconstitution
- Student protection kit
- Ostomy pouch, wafer, 1-3/4" & closure
- Lister scissors, stainless steel, 5-1/2"
- Baxter 0.9% NaCl - 50mL & 500mL
- Baxter Clearlink secondary IV set, 37"
- Baxter Clearlink primary IV set, 1 luer valve, 76"
- BD 3mL syringe only, luer lock
- BD Autoguard IV catheter, 22g x 1"
- BD Autoguard IV catheter 20g x 1.16"
- Smiths TB syringe, 1mL, fixed 27g x 1/2"
- Urethral catheter tray, vinyl, PVP, 14Fr
- Central line dressing change tray
- Kendall argyle salem sump tube, 48", 14Fr
- Tote bag, Black/Blue, zipper



#270106	Nursing Supply Kit	1/each	\$89.99
---------	--------------------	--------	----------------

PHLEBOTOMY KIT

Includes:

- Phlebotomy tote
- Safety glasses with sideshield
- BD needle holder
- Sharpie permanent marker (*Black, fine point*)
- 1 qt Sharps container, Red, phlebotomy
- 3M Transpore clear plastic tape, 1" x 10 yards
- (2) BD Vacutainer® citrate plus plastic tubes
- (2) BD Vacutainer Plus plastic blood collection tubes (EDTA), Lavender
- (2) BD Vacutainer® Plus plastic blood collection (serum), red
- (2) Non-latex tourniquets, 1" x 18"
- (3) BD Safetyglide needle only, 21g x 1-1/2"
- (3) BD needle only, 22g x 1"
- (10) Pairs Nitriderm powder-free surgical gloves, size 7.0, (*sterile*)
- (20) Sterile alcohol prep pads, (*medium*)
- (20) Gauze sponges 2" x 2" 8-ply (2s) (*sterile*)
- (20) Flexible bandage strips, fabric, 1" x 3" (*sterile*)



#270102	Phlebotomy Kit	1/each	\$33.99
---------	----------------	--------	----------------

IV THERAPY KIT

Includes:

- IV Start Kit with Tegaderm without gloves, 3M tape, sterile, latex free
- Baxter Clearlink Primary IV Set, (3) luer valves, 109"
- Baxter Clearlink Secondary IV Set, 37"
- Baxter 0.9% NaCl, 50mL
- BD Insyte Autoguard IV catheter, Blue, 22g x 1"
- Insyte Autoguard Winged IV catheter, 20g x 1", Pink
- 36" Micro volume extension set
- Pre-filled normal saline syringe, 3mL fill in 3mL syringe (Rx)
- Training vial, Powder - Y, gm, 10ml vial
- Sencicare sterile PF vinyl exam gloves, medium, pairs
- Medical Shipment drawstring tote, Blue
- Insyte Autoguard winged IV catheter, 20g x 1", Pink



#270101	IV Therapy Kit	1/each	\$31.99
---------	----------------	--------	----------------

KIT PACKS

STUDENT PROTECTION KIT

Includes:

- Isolation gown (*Yellow*)
- Bouffant cap
- Mask with ties
- (1) Pair latex-free non-sterile gloves
- (1) Pair shoe covers

#120801	Student Protection Kit	1/each	\$2.90
---------	------------------------	--------	---------------



INFECTION CONTROL KIT

Includes:

- 12" x 15" 2mL resealable bag
- Mask with eyeshield
- Impervious no gamma gown
- Large bouffant head cover
- (1) Latex-free gloves, medium (*pair*)
- (2) XL 3-layer shoe covers
- (2) Antiseptic towelettes

#300202	Infection Control Kit	1/each	\$9.99
---------	-----------------------	--------	---------------



ACCESSORIES KIT

Includes:

- Reusable penlight with pupil gauge
- Calculator
- 5-1/2" Lister bandage scissors
- Tape measure
- Thermometer with (20) sheaths
- Vinyl wallet
- Sharpie marker (*Black*)

#300203	Accessories Kit	1/each	\$15.99
---------	-----------------	--------	----------------



INSULIN INJECTION TRAINING KIT

Includes:

- Injection pad with strap
- Training insulin, NPH
- Training insulin, regular, 1000 units/10mL Vial
- (4) Alcohol prep pad, medium (*sterile*)
- BD SafetyGlide insulin PA 1mL 29g x 1/2"
- Exel insulin PA syringe, 1mL, 28g x 1/2"

#300204	Insulin Injection Kit	1/each	\$12.99
---------	-----------------------	--------	----------------



OSTOMY KIT

Includes:

- 4" x 4" wafer with flange, 1-3/4", 12"
- Drainable pouch with 1-3/4" flange
- Pouch clamp
- (2) Alcohol prep pads

#300205	Ostomy Kit	1/each	\$10.99
---------	------------	--------	----------------



Syringes/Needles



SYRINGE ONLY (Luer Lock)

- Feature a clear barrel with bold scale markings, tapered plunger
- Positive plunger rod stop, and an added BD Luer-Lok™ thread for increased secure connection
- Packaging is latex free

#200918bx	3mL	200/box	\$18.99
#200919bx	5mL	125/box	\$18.99
#200920bx	10mL	100/box	\$15.99
#200921bx	20mL	48/box	\$17.99
#200948bx	30mL	56/box	\$24.99
#200715bx	60mL	40/box	\$25.99



SYRINGE/NEEDLE COMBINATION (Luer Lock)

- Clear, bold markings with exceptionally sharp needle
- Smooth plunger action

#200930bx	3mL	22g x 1"	100/bx	\$17.99
#200931bx	3mL	22g x 1-1/2"	100/bx	\$16.75
#200932bx	3mL	25g x 5/8"	100/bx	\$16.75
#200933bx	3mL	25g x 1"	100/bx	\$17.99
#200934bx	10mL	22g x 1"	100/bx	\$34.99



SAFETYGLIDE™ LATEX-FREE SYRINGES

- Syringes are safety-engineered
- Features a detachable needle (with shielding mechanism), and a regular bevel
- Sterile

#200822bx	3mL	22g x 1-1/2"	50/box	\$21.50
#200812bx	3mL	23g x 1"	50/box	\$21.50
#200823bx	5mL	22g x 1-1/2"	50/box	\$25.50
#200824bx	10mL	22g x 1-1/2"	50/box	\$30.99
#201003bx	1mL IM	25g x 5/8"	100/box	\$49.99



SAFETYGLIDE™ INSULIN PA SYRINGES

(with Permanently Attached Needle)

- Designed for minimal dead space
- Rotating safety arm allows for bevel-up orientation and low-angle injections
- Safety arm is activated with a single fingerstroke

#200303bx	1mL	29g x 1/2"	100/box	\$45.75
#200304bx	1/2mL	29g x 1/2"	100/box	\$45.75
#200305bx	3/10mL	29g x 1/2"	100/box	\$45.75
#200309bx	1mL (U-100) PA	28g x 1/2"	100/box	\$32.99

INTEGRA™ SYRINGE (3mL)

- Retracting needle housed inside the syringe
- Detachable needle
- Low waste space

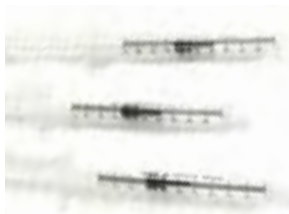

#200108bx	25g x 5/8"	100/box	\$21.95
#200109bx	25g x 1"	100/box	\$69.99
#200110bx	23g x 1"	100/box	\$69.99
#200111bx	22g x 1-1/2"	100/box	\$69.99
#200112bx	21g x 1"	100/box	\$69.99
#200113bx	21g x 1-1/2"	100/box	\$69.99

BD /ECLIPSE™/INTEGRA™



LATEX-FREE NEEDLES

- Engineered for minimal penetration and drag
- Comes in regular wall type and regular bevel

#200945bx	18g x 1"	100/box	\$9.75
#200943bx	22g x 1"	100/box	\$10.99
#200944bx	22g x 1-1/2"	100/box	\$11.99
#200942bx	25g x 5/8"	100/box	\$10.99
#200946bx	26g x 5/8"	100/box	\$10.99



PRECISIONGLIDE™ NEEDLES

- Needles attach to any standard BD Luer-Lok™ or luer-slip hypodermic syringe, and twist into place

#200828bx	21g x 1-1/2"	50/box	\$20.95
#200827bx	22g x 1-1/2"	50/box	\$20.95
#200809bx	23g x 1"	50/box	\$20.95
#200826bx	25g x 5/8"	50/box	\$20.95
#200825bx	25g x 1"	50/box	\$19.99



ECLIPSE™ NEEDLE ONLY

- Bevel-oriented needle for low angle injections
- Sterile

#200972bx	18g x 1-1/2"	100/box	\$27.99
#200970bx	21g x 1"	100/box	\$27.99
#200971bx	21g x 1-1/2"	100/box	\$27.99
#200974bx	22g x 1"	100/box	\$27.99
#200969bx	22g x 1-1/2"	100/box	\$27.99
#200968bx	23g x 1"	100/box	\$27.99
#200967bx	25g x 1"	100/box	\$27.99
#200973bx	25g x 1-1/2"	100/box	\$27.99

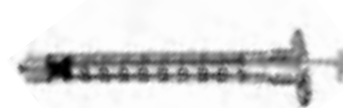

ECLIPSE™ NEEDLE WITH SYRINGE (Detachable Needle)

- Single-handed activation
- Bevel-oriented needle for low angle injections
- Luer-Lok™
- Sterile

#200102bx	1mL	30g x 1/2"	50/box	\$29.99
#200103bx	1mL	27g x 1/2"	50/box	\$29.99
#200104bx	1mL	25g x 5/8"	50/box	\$28.99
#200105bx	3mL	25g x 1"	50/box	\$16.99
#200106bx	3mL	25g x 5/8"	50/box	\$16.99
#200107bx	3mL	23g x 1"	50/box	\$16.99



TB SYRINGES

#201007bx	1mL (LS)	27g x 1/2"	100/box	\$21.95
#201008bx	1m (LS)L	25g x 5/8"	100/box	\$69.99
#201002bx	1mL (PA)	26g x 3/8"	100/box	\$45.75
#201001bx	1mL (PA)	27g x 1/2"	100/box	\$45.75

NEED A PURCHASE ORDER? IT'S AS EASY AS 1, 2, 3:

1. Choose your items online
2. Click "Add to Quote" box
3. Give shipping details & receive your quote instantly!

Syringes/Needles

BAK'SNAP



BAK'SNAP SYRINGE WITH NEEDLE (3mL Luer Lock)

#200841bx	3mL	20g x 1-1/2"	100/box	\$24.99
#200842bx	3mL	21g x 1"	100/box	\$24.99
#200843bx	3mL	21g x 1-1/2"	100/box	\$24.99
#200844bx	3mL	22g x 1"	100/box	\$24.99
#200845bx	3mL	22g x 1-1/2"	100/box	\$24.99
#200846bx	3mL	23g x 1"	100/box	\$24.99
#200847bx	3mL	25g x 5/8"	100/box	\$24.99
#200848bx	3mL	25g x 1"	100/box	\$24.99



BAK'SNAP SYRINGE WITH NEEDLE (5mL, 10mL Luer Lock)

#200850bx	5mL	20g x 1-1/2"	100/box	\$34.99
#200851bx	5mL	21g x 1"	100/box	\$34.99
#200852bx	5mL	21g x 1-1/2"	100/box	\$34.99
#200853bx	5mL	22g x 1"	100/box	\$34.99
#200854bx	5mL	22g x 1-1/2"	100/box	\$34.99
#200856bx	10mL	21g x 1"	50/box	\$23.99



BAK'SNAP TB SYRINGE

#201009bx	1mL	25g x 5/8"	100/box	\$32.99
#201010bx	1mL	25g x 1"	100/box	\$32.99
#201011bx	1mL	26g x 3/8"	100/box	\$32.99
#201012bx	1mL	27g x 1/2"	100/box	\$32.99



SYRINGE ONLY (Luer Lock)

#200840bx	3mL	100/box	\$23.99
#200849bx	5mL	100/box	\$25.99
#200855bx	10mL	100/box	\$23.99
#200857bx	20mL	100/box	\$27.99



SAFETY'TRAY SYRINGE ALLERGY TRAY

#200859bx	1mL	26g x 3/8"	100/box	\$32.99
#200860bx	1mL	27g x 1/2"	100/box	\$32.99



SAFETY'TRAY SYRINGE FLU TRAY

#200858bx	1mL	25g x 1"	100/box	\$32.99
-----------	-----	----------	---------	----------------



INSO'SAFE INSULIN SYRINGE

#200310bx	0.5mL	29g x 1/2"	100/box	\$32.99
#200311bx	1mL	29g x 1/2"	100/box	\$32.99



See New Products 

Pages 128-133



LATEX-FREE NEEDLE ONLY

- Color-coded packaging by size for easy identification
- Non toxic, non pyrogenic
- Sterile

#200941bx	18g x 1"	100/box	\$5.99
#200935bx	21g x 1-1/2"	100/box	\$5.99
#200938bx	22g x 1"	100/box	\$5.99
#200940bx	22g x 1-1/2"	100/box	\$5.99
#200939bx	23g x 1"	100/box	\$5.99
#200937bx	25g x 5/8"	100/box	\$5.99
#200936bx	27g x 1/2"	100/box	\$5.99



SYRINGE/NEEDLE COMBINATION

- Luer Lok™
- Non toxic and non pyrogenic

#200922bx	3mL	22g x 1"	100/box	\$8.99
#200923bx	3mL	22g x 1-1/2"	100/box	\$8.99
#200924bx	3mL	25g x 5/8"	100/box	\$8.99
#200925bx	3mL	27g x 1-1/4"	100/box	\$8.99
#200926bx	5mL	22g x 1"	100/box	\$19.50
#200927bx	5mL	22g x 1-1/2"	100/box	\$19.50
#200928bx	10mL	22g x 1"	100/box	\$23.99
#200929bx	10mL	22g x 1/2"	100/box	\$23.99



LATEX-FREE INSULIN PA SYRINGES

- Sterile
- Features permanently attached needle with reduced dead space
- Non toxic and non pyrogenic
- 100/box

#200306bx	0.5mL	28g x 1/2"	\$10.75
#200307bx	1mL	28g x 1/2"	\$10.75



LATEX-FREE SYRINGES ONLY (Luer Lok™)

- Sterile
- Individual blister packs
- Non toxic and non pyrogenic

#200913bx	5mL	100/box	\$7.99
#200914bx	5mL	100/box	\$13.99
#200915bx	10mL	100/box	\$13.99
#200916bx	20mL	50/box	\$16.99
#200917bx	30mL	50/box	\$24.99



1ML TB SYRINGES LS

- Easy-to-activate safety feature keeps clinician's hands and fingers behind the disposal

#201004bx	27g x 1/2"	100/box	\$24.99
#201005bx	25g X 5/8"	100/box	\$10.99
#201006bx	25g X 5/8"	100/box	\$19.99

Putting Nurses at the Heart of the Solution!

Syringes/Needles

KENDALL



MONOJECT LATEX-FREE HYPODERMIC NEEDLE)

- Sterile
- Color coded Luer Lock hub
- Gauge stripe and bar code on individual package

#200950bx	Green	18g x 1"	100/box	\$7.95
#200951bx	Pink	20 g x 1.5"	100/box	\$7.95
#200952bx	Lavender	21g x 1"	100/box	\$7.95
#200953bx	Lavender	21g x 1.5"	100/box	\$7.95
#200954bx	Blue	22g x 1"	100/box	\$7.95
#200955bx	Blue	22g x 1.5"	100/box	\$7.95
#200956bx	Orange	23g x 1"	100/box	\$7.95
#200957bx	Red	25g x 5/8"	100/box	\$7.95
#200958bx	Red	25g x 1"	100/box	\$7.95
#200959bx	White	26g x 1.5"	100/box	\$7.95
#200960bx	White	27 g x 0.5"	100/box	\$7.95

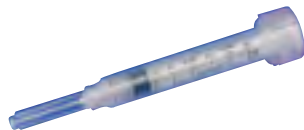

SYRINGE ONLY

- Without needles, in individual blister packs
- Non toxic and non pyrogenic

#200716bx	3mL	Regular Tip 0.1cc Graduations	100/box	\$12.99
#200717bx	3mL	Luer Lock Tip 0.1cc Graduations	100/box	\$12.99
#200718bx	6mL	Regular Tip 0.2cc Graduations	50/box	\$10.99
#200719bx	6mL	Luer Lock Tip 0.2cc Graduations	50/box	\$10.99
#200720bx	20mL	Regular Tip 0.1cc Graduations	50/box	\$23.00
#200721bx	20mL	Luer Lock Tip 0.1cc Graduations	50/box	\$30.99
#200722bx	35mL	Luer Lock Tip 0.1cc Graduations	30/box	\$21.99

MONOJECT INSULIN SAFETY SYRINGE

- Helps keep clinicians safe with maximum clinical flexibility
- Complies with OSHA Bloodborne Pathogens Standard for Engineering Controls

#200312bx	0.3mL	29g x 1/2"	100/box	\$34.95
#200313bx	0.5mL	21g x 1"	100/box	\$7.75
#200314bx	1mL	29g x 1/2"	100/box	\$31.50
#200315bx	0.3mL	30g x 5/16"	100/box	\$34.50
#200316bx	0.5mL	230g x 5/16"	100/box	\$34.50



MONOJECT mL

- Sterile
- Single use engineering control
- Protects the user from accidental needle stick injuries

#200831bx	22g x 1"	100/box	\$39.99
#200832bx	22g x 1-1/2"	100/box	\$37.99
#200834bx	25g x 5/8"	100/box	\$37.99



MONOJECT 1ML TB SAFETY SYRINGE

- Sterile
- Single-use, individually packaged syringe with or without attached needle

#200317bx	28g x 1/2"	100/box	\$13.99
#200318bx	29g x 1/2"	100/box	\$13.99
#200319bx	30g x 5/15"	100/box	\$19.99



1mL TB LUER SLIP LATEX-FREE SYRINGE ONLY (Sterile)

- Transparent barrel with clear graduations
- Double seal stopper to help prevent medication leakage

#201015bx	1cc	0.1mL Graduations	100/box	\$9.99
#200864bx	3cc	0.5mL Graduations	100/box	\$9.99
#200865bx	5cc	1mL Graduations	100/box	\$12.99
#200866bx	10cc	1mL Graduations	100/box	\$15.99
#200867bx	20cc	1mL Graduations	100/box	\$37.99
#200898bx	30cc	5mL Graduations	100/box	\$48.99



MEDI-PAK™ PERFORMANCE SAFETY NEEDLE

- Sterile
- Transparent barrel with clear graduations
- Double seal stopper to help prevent medication leakage

#200874bx	Thin Wall	18g x 1"	100/box	\$27.99
#200875bx	Thin Wall	18g x 1-1/2"	100/box	\$27.99
#200876bx	Ultra Thin Wall	20g x 1"	100/box	\$27.99
#200877bx	Ultra Thin Wall	21g x 1"	100/box	\$27.99
#200878bx	Ultra Thin Wall	21g x 1-1/2"	100/box	\$27.99
#200879bx	Ultra Thin Wall	21g x 1-1/2"	100/box	\$27.99
#200880bx	Ultra Thin Wall	22g x 1"	100/box	\$27.99
#200881bx	Ultra Thin Wall	23g x 1"	100/box	\$27.99
#200882bx	Ultra Thin Wall	23g x 1-1/2"	100/box	\$27.99
#200883bx	Ultra Thin Wall	25g x 5/8"	100/box	\$27.99
#200884bx	Ultra Thin Wall	25g x 1"	100/box	\$27.99
#200885bx	Regular Wall	25g x 1-1/2"	100/box	\$27.99
#200886bx	Regular Wall	27g x 1/2"	100/box	\$27.99
#200887bx	Regular Wall	30g x 1/2"	100/box	\$27.99



3mL MEDI-PAK™ PERFORMANCE SYRINGE WITH SAFETY NEEDLE (Sterile)

- Unique needle locking mechanism helps reduce risk of needlestick injury
- 0.1cc graduations

#200869bx	22 x 1"	100/box	\$32.99
#200870bx	22g x 1-1/2"	100/box	\$32.99
#200871bx	23g x 1"	100/box	\$32.99
#200873bx	25g x 5/8"	100/box	\$32.99



1mL LATEX-FREE TUBERCULIN SYRINGE

- Sterile
- Transparent barrel with clear graduations
- Double seal stopper to help prevent leakage
- 100/box

#201016bx	25g x 5/8"	0.1mL Graduations	\$13.99
#201017bx	27g x 1/2"	0.5mL Graduations	\$13.99

NEED A QUOTE? IT'S AS EASY AS 1, 2, 3:

1. Choose your items online
2. Click "Add to Quote" box
3. Give shipping details & receive your quote instantly!

Syringes/Needles

SMITHS



NEEDLE-PRO® EDGE SYRINGE (with Protection Device)

- Needle securely locks inside safety device and remains protected through disposal
- Meets NIOSH/CDC recommendations for safety devices
- 3mL
- Luer Lock

#201111bx	18g x 1" needle	Pink	50/box	\$27.99
#201112bx	18g x 1-1/2" needle	Pink	50/box	\$18.99
#201113bx	19g x 1" needle	Cream	50/box	\$18.99
#201114bx	19g x 1-1/2" needle	Cream	50/box	\$18.99
#201115bx	20g x 1" needle	Yellow	50/box	\$18.99
#201116bx	20g x 1-1/2" needle	Yellow	50/box	\$18.99
#201108bx	21g x 1" needle	Green	50/box	\$27.99
#201117bx	21g x 1-1/2" needle	Green	50/box	\$27.99
#201107bx	22g x 1" needle	Black	50/box	\$18.99
#201106bx	22g x 1-1/2" needle	Black	50/box	\$31.99
#201105bx	23g x 1" needle	Blue	50/box	\$18.99
#201118bx	25g x 1" needle	Orange	50/box	\$18.99
#201104bx	25g x -5/8" needle	Orange	50/box	\$18.99

INSULIN SYRINGE

- Easy-to-activate safety feature that keeps clinician's hands and fingers behind the exposed sharp
- Needle securely locks inside safety device and remains protected through disposal

#201119bx	22 x 1"	100/box	\$34.99
#201109bx	22g x 1-1/2"	100/box	\$34.99
#201120bx	23g x 1"	100/box	\$34.99

HYPODERMIC NEEDLE-PRO® INSULIN SYRINGE (Fixed Needle)

- Meets NIOSH/CDC recommendations for safety devices

#201121bx	0.3 mL	29g x 1/2"	100/box	\$34.99
#201122bx	0.3 mL	30g x 1/2"	100/box	\$59.99
#201110bx	0.5 mL	29g x 1/2"	100/box	\$34.99
#201123bx	0.5 mL	30g x 1/2"	100/box	\$34.99

1 mL TB SYRINGE (Fixed Needle)

- Needle securely locks inside safety device and remains protected through disposal

#201101bx	25g x 5/8"	100/box	\$38.99
#201102bx	26g x 3/8"	100/box	\$38.99
#201103bx	27g x 1/2"	100/box	\$38.99



NEW SURGUARD 3™ SAFETY SYRINGE

- 3 modes of activation—thumb, finger, or hard surface
- Separate finger/thumb grips with ridges and nonslip surfaces



#200888bx	1mL	25g x 5/8"	100/box	\$59.99
#200889bx	1mL	27g x 1/2"	100/box	\$59.99
#200890bx	1mL	20g x 1"	100/box	\$34.99
#200891bx	3mL	20g x 1-1/2"	100/box	\$34.99
#200892bx	3mL	21g x 1"	100/box	\$34.99
#200893bx	3mL	21g x 1-1/2"	100/box	\$34.99
#200894bx	3mL	22g x 1"	100/box	\$34.99
#200895bx	3mL	22g x 1-1/2"	100/box	\$34.99
#200896bx	3mL	25g x 5/8"	100/box	\$59.99
#200897bx	3mL	25g x 1"	100/box	\$34.99

Committed to Providing Quality Products

SURGUARD 3™ SAFETY NEEDLE

- Hub and needle locks for security post activation
- Separate finger/thumb grips with ridges and nonslip surfaces



#200899bx	18g x 1-1/2"	100/box	\$28.99
#200700bx	20g x 1"	100/box	\$28.99
#200701bx	20g x 1-1/2"	100/box	\$28.99
#200703bx	21g x 1"	100/box	\$28.99
#200704bx	21g x 1-1/2"	100/box	\$28.99
#200705bx	22g x 1"	100/box	\$28.99
#200706bx	22g x 1-1/2"	100/box	\$28.99
#200707bx	23g x 1"	100/box	\$28.99
#200708bx	23g x 1-1/2"	100/box	\$28.99
#200709bx	25g x 5/8"	100/box	\$28.99
#200710bx	25g x 1"	100/box	\$28.99
#200711bx	25g x 1-1/2"	100/box	\$28.99
#200712bx	27g x 1/2"	100/box	\$28.99
#200713bx	30g x 1/2"	100/box	\$28.99



MEDICAL · SHIPMENT
Nursing Education Supply Experts, At Your Service



Training Headwall Units

FOR TEACHING LABS & INSTITUTIONS

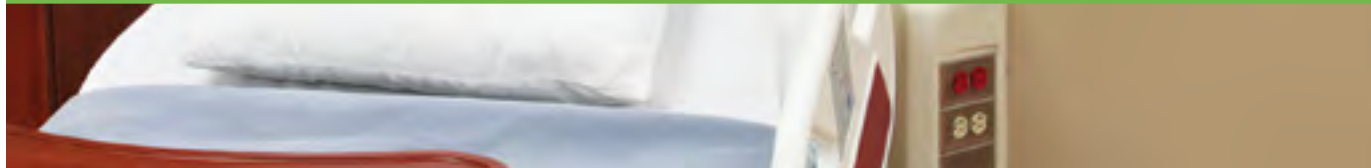

FUNCTIONAL AND NON-FUNCTIONAL WALL MOUNTED AND MOBILE

Choose the Right System for Your Lab

Headwall Units are available in functional or non-functional versions. Configurations can be private or semi-private; wall-mounted or mobile. For maximum utility and ease of practice choose our movable, two-sided headwall.

Included on all headwall units:

- Air, oxygen & vacuum outlets
- Accessories



A plug-and-play Headwall that provides the quickest method for simulating medical devices in a patient's room.



Private/Semi-Private Training Headwall

Movable Two-Sided Headwall

To learn more visit us at
MedicalShipment.com

Call us at
(847) 253-3000

All accessories included in every package



SAPPHIRE MOBILE TRAINING HEADWALL *(Functional)*

Features:

- Duplex emergency
- Plug and play headwall
- Compressed air inlet receptacle
- Compressor line/tank
- Vacuum slide with moisture trap
- Nurse call cover
- Super silent compressor
- Mounting strip
- Vacuum regulator
- Floor stand with tubing nipple "T"

Accessories:

- (1) Vacuum regulator (Intermittent/Continuous)
- (1) Oxygen flowmeter with humidifier
- (1) Air flowmeter
- (1) 1500mL Canister with tubing
- (1) Utility basket

#250103	36" Headwall	\$4,599.00
#250105	48" Headwall	\$4,999.00
#250108*	60" Semi-Private	\$5,199.00
#250109*	72" Semi-Private	\$5,299.00

*60" and 72" Headwalls include (2) sets of accessories

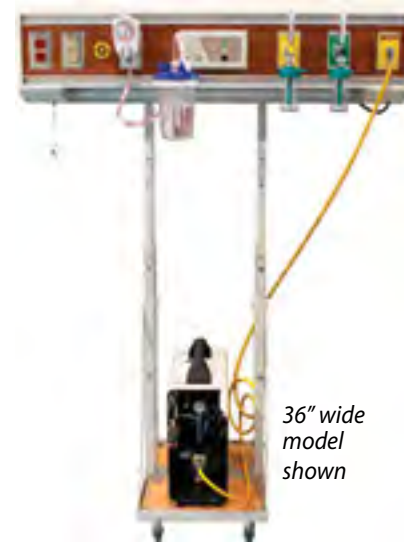

36" wide model shown

Committed to Providing Quality Products

VERTICAL FLATWALL *(Functional)*

- Plug and play headwall that generates vacuum, air and simulated oxygen
- Inexpensive
- Self contained and solves all of the typical problems associated with a nursing simulation lab installation

Accessories:

- (1) Vacuum regulator (Intermittent/Continuous)
- (1) Oxygen flowmeter with humidifier
- (1) Air flowmeter
- (1) 1500mL Canister with tubing
- (1) Utility basket

#250110	Private	\$5,299.00
#250111	Semi-Private	\$5,999.00



Training Headwall Units

FUNCTIONAL/NON-FUNCTIONAL



TRAINING HEADWALL (Functional)

- Oxygen, air and vacuum outlet
- Vacuum bottle slide
- Red electrical receptacle
- Ivory electrical receptacle
- Air compressor
- Timer switch for pump & compressor
- 36" H x 21" W x 6" D

Accessories:

- (1) Vacuum regulator (Intermittent/Continuous)
- (1) Oxygen flowmeter with humidifier
- (1) Air flowmeter
- (1) 1500mL Canister with tubing
- (1) Utility basket

#250101	Private	\$3,999.00
#250102*	Semi-Private	\$4,999.00

*Semi-private units include (2) sets of accessories



MOVABLE TWO-SIDED HEADWALL (Functional)

Includes:

- (2) Self-contained, low noise vacuum pumps—plus an air compressor, timer switch, and a 6' power cord at the bottom of the unit
- 60" H x 21" W x 6" D

Accessories:

- (1) Vacuum regulator (Intermittent/Continuous)
- (1) Oxygen flowmeter with humidifier
- (1) Air flowmeter
- (1) 1500mL Canister with tubing
- (1) Utility basket

#250104	Semi-Private	1/each	\$5,499.00
---------	--------------	--------	-------------------



TRAINING HEADWALL (Non Functional)

Includes:

- Oxygen outlet
- Vacuum outlet
- Vacuum pump
- Vacuum bottle slide
- Medical air outlet
- Red electrical receptacle
- Ivory electrical receptacle
- 36" H x 21" W x 6" D

Accessories:

- (1) Vacuum regulator (Intermittent/Continuous)
- (1) Oxygen flowmeter with humidifier
- (1) Air flowmeter
- (1) 1500mL Canister with tubing
- (1) Utility basket

#250201	Private	\$1,199.00
#250202*	Semi-Private	\$1,499.00

*Semi-private units include (2) sets of accessories

ACCESSORIES



4' HORIZON-8™ OVERBED LIGHT FIXTURE

#250334 1/each **\$950.00**



4' AURORA™ OVERBED LIGHT FIXTURE

#250308 1/each **\$999.00**



1500mL SUCTION CANISTER

#250304 1/each **\$7.99**



UTILITY BASKET WITH MOUNT

• 10" W x 10" H x 4" D

#250306 1/each **\$99.00**



SUCTION TUBING *(Blue-Tipped Tube)*

• 1/4" W x 15" L

#250307 1/each **\$2.99**



SUCTION CANISTER HOLDER

#250305 1/each **\$4.99**



AIR FLOWMETER

#250302 1/each **\$46.99**



OXYGEN FLOWMETER

#250303 1/each **\$46.99**



VACUUM REGULATOR
(Intermittent/Continuous)

#250301 1/each **\$325.00**

Product Index (BY ITEM #)

ITEM #	PAGE				
8501	6, 157	110116bx	50	110212cs	52
8501cs	4	110116cs	50	110213bx	52
8502	6, 157	110117bx	50	110213cs	52
8502cs	4	110117cs	50	110214bx	52
8503	6	110118bx	50	110214cs	52
8503cs	4	110118cs	50	110215bx	52
8504	7, 159	110119bx	50	110215cs	52
8504cs	5	110119cs	50	110216bx	52
8505	7	110123bx	50	110216cs	52
8505cs	5	110124bx	50	110217bx	52
8506	7	110125bx	50	110218bx	52
8506cs	5	110126bx	50	110219bx	52
8508bx	6, 135	110127bx	50	110220bx	52
8508cs	5, 135	110128bx	50	110221bx	52
8509	6, 135	110129bx	50	110222bx	52
8509cs	5, 135	110130bx	50	110223bx	52
108104pk	191	110131bx	50	110224bx	52
110101bx	50	110132bx	50	110225bx	52
110101cs	50	110133bx	50	110226bx	52
110102bx	50	110134bx	50	110301cs	53
110102cs	50	110135bx	50	110302cs	53
110103bx	50	110201bx	52	110303cs	53
110103cs	50	110202bx	52	110304cs	53
110105bx	50	110203bx	52	110305cs	53
110105cs	50	110204bx	52	110306cs	53
110106cs	50	110205bx	52	110310bx	51
110109bx	50	110205cs	52	110310cs	51
110109cs	50	110206bx	52	110311bx	51
110110bx	50	110206cs	52	110311cs	51
110110cs	50	110207bx	52	110312bx	51
110111bx	50	110207cs	52	110312cs	51
110111cs	50	110208bx	52	110313bx	51
110112bx	50	110208cs	52	110313cs	51
110112cs	50	110209bx	52	110314bx	51
110113bx	50	110209cs	52	110314cs	51
110113cs	50	110210bx	52	110315bx	51
110114bx	50	110210cs	52	110315cs	51
110114cs	50	110211bx	52	110317bx	53
110115bx	50	110211cs	52	110318bx	53
110115cs	50	110212bx	52	110319bx	53
				110320bx	53
				110321bx	53
				110322bx	53
				110323bx	53
				110324bx	53
				110325bx	53
				110326bx	53
				110327bx	53
				110328bx	53
				110401bx	53
				110402bx	53
				110403bx	53
				110404bx	53
				110405bx	53
				110406bx	53
				110407bx	53
				110408bx	53
				110409bx	53
				110410bx	53
				110411bx	53
				110412bx	53
				110413bx	53
				110414bx	53
				110415bx	53
				110416bx	53
				110417bx	53
				110418bx	53
				110419bx	53
				110420bx	53
				110421bx	53
				110501bx	51
				110501cs	51
				110502bx	51
				110502cs	51
				110503bx	51
				110503cs	51
				110504bx	51
				110504cs	51
				110509bx	51
				110509cs	51
				110510bx	51
				110510cs	51
				110511bx	51
				110511cs	51
				110512bx	51
				110512cs	51
				110513bx	51
				110514bx	51
				110515bx	51
				110516bx	51
				110517bx	51
				110518bx	51
				110519bx	51
				110520bx	51
				110521bx	51
				110601bx	53
				110601cs	53
				110602bx	53
				110602cs	53
				110603bx	53
				110603cs	53
				110604bx	53
				110604cs	53
				120000	141
				120001	141
				120002	141
				120004bg	139
				120005bg	139
				120006bg	139
				120010pk	139
				120011pk	139
				120012pk	139
				120013pk	139
				120014bg	140
				120015bx	140
				120016bx	140
				120018bx	140
				120019bx	140
				120020bx	140
				120034cs	140



Thank you for your order!

FAX: 1-847-506-0524

Product Index (BY ITEM #)



ITEM #	PAGE				
120035cs.....	140	120203.....	161	120437.....	158
120038bx.....	139	120204.....	161	120438.....	158
120042bx.....	139	120205.....	161	120441.....	159
120043bx.....	139	120206.....	161	120447.....	157
120044bx.....	140	120207.....	162	120500.....	165
120045bx.....	140	120208.....	162	120502.....	165
120046.....	156	120209.....	160	120505.....	171
120047.....	156	120210.....	159	120509.....	171
120050.....	143	120211.....	159	120511.....	171
120051bx.....	143	120212.....	160	120513.....	171
120052bx.....	143	120213.....	160	120515.....	171
120055bx.....	137	120305.....	154	120516bg.....	149
120101bx.....	145	120306.....	154	120517.....	149
120104bx.....	144	120311bx.....	154	120518bg.....	149
120106cs.....	145	120312bx.....	154	120519.....	149
120107bx.....	144	120320.....	154	120521.....	150
120109bx.....	144	120321.....	154	120521bx.....	150
120110bx.....	144	120322.....	176	120522bx.....	150
120111bx.....	144	120323.....	176	120523.....	150
120112bx.....	145	120324.....	176	120523bg.....	150
120113.....	145	120336.....	175	120523cs.....	150
120114.....	145	120337.....	175	120527.....	150
120115.....	145	120338.....	175	120527bg.....	150
120116.....	145	120339.....	175	120527cs.....	150
120117bx.....	145	120340.....	175	120529bx.....	149
120118cs.....	145	120341.....	175	120530.....	155
120119bx.....	145	120342.....	175	120531.....	155
120120cs.....	153	120343.....	175	120533pk.....	154
120121cs.....	153	120344.....	175	120534bx.....	154
120122.....	144	120352.....	129	120535bx.....	150
120123.....	144	120353.....	129	120536.....	167
120124.....	144	120426.....	157	120537.....	167
120125.....	144	120428.....	158	120538.....	167
120126.....	145	120430.....	157	120539.....	167
120127.....	153	120431.....	157	120540bx.....	152
120128.....	145	120432.....	157	120540cs.....	152
120129.....	145	120433.....	158	120541cs.....	152
120130.....	145	120434.....	158	120543.....	150
120131.....	145	120435.....	158	120544.....	151
120201.....	161	120436.....	158	120545.....	151
				120546.....	152
				120547.....	152
				120548.....	150
				120549.....	150
				120550bx.....	149
				120551.....	151
				120553pk.....	146
				120554bx.....	152
				120555bx.....	156
				120556.....	153
				120557.....	153
				120558bx.....	149
				120559.....	136
				120560.....	152
				120561.....	152
				120562.....	152
				120563.....	151
				120564.....	170
				120565.....	170
				120566.....	170
				120567.....	170
				120568.....	170
				120569.....	170
				120570.....	170
				120571.....	170
				120572.....	170
				120573.....	170
				120574.....	170
				120575.....	152
				120576.....	159
				120577.....	152
				120579.....	155
				120580.....	151
				120581.....	170
				120590.....	152
				120594.....	166
				120595.....	166
				120596.....	166
				120598.....	167
				120599.....	165
				120601.....	151
				120604.....	146
				120605.....	146
				120607.....	146
				120609pk.....	146
				120610.....	152
				120613.....	151
				120619.....	148
				120621bx.....	146
				120622.....	146
				120623.....	152
				120624.....	152
				120625bx.....	146
				120626.....	146
				120627.....	151
				120628.....	151
				120629.....	151
				120630.....	151
				120631.....	146
				120632.....	147
				120633bx.....	156
				120634.....	156
				120635.....	148
				120637.....	148
				120638.....	148
				120639bx.....	146
				120640.....	148
				120641.....	148
				120642.....	148
				120643.....	148
				120646.....	147
				120647.....	147
				120648.....	147
				120649.....	147
				120650.....	147
				120651.....	147
				120652.....	147
				120653.....	147
				120654.....	147
				120655.....	147

Product Index (BY ITEM #)

ITEM #	PAGE				
120702bx	138	120757bx	142	120799	136
120705bx	136	120758bx	140	120801	144, 211
120706bx	136	120759bx	142	120901	137
120708bx	134	120760bx	142	120902bx	136
120709bx	134	120761bx	142	120903bx	136
120710bx	134	120762bg	135	120904bx	138
120711bx	134	120763bx	136	120905bx	137
120713pk	135	120764bx	138	120906	142
120714pk	135	120765bx	138	120906cs	142
120717bx	135	120766	141	120908bx	138
120718bx	138	120767	141	120909bx	138
120720bx	138	120768	141	120910	142
120721bx	139	120769	141	120911	142
120722bx	139	120771bx	139	120913	156
120724bx	139	120772bx	139	120914	155
120725bx	139	120773bx	139	120915	163
120727bx	139	120774	139	120916	163
120728cs	140	120775	163	120917	137
120729cs	140	120776	163	120918	162
120733bx	134	120777bx	163	120920	162
120734bx	134	120778bx	136	120921	162
120735bx	134	120779bx	136	120922	137
120736bx	134	120780bx	142	120923	137
120738bx	139	120781bx	134	120944	141
120739bx	139	120782bx	134	120945	141
120740bx	139	120783bx	134	120946	141
120741bx	139	120784bx	134	120947	141
120743bx	140	120785bx	134	120952	141
120744bx	140	120786bx	134	120959cs	141
120745bx	140	120787bx	134	120960cs	141
120746bx	140	120788bx	134	120961cs	141
120747bx	140	120789bx	134	120966	141
120748bx	140	120790bx	134	120967	141
120749bx	140	120791bx	138	120968	141
120751bx	134	120792bx	138	120969	141
120752bx	134	120793bx	138	120970	141
120753bx	134	120795bx	151	120980	141
120754bx	134	120796	135	120981	141
120755bx	142	120797	135	120982	141
120756bx	142	120798	136	120983	141
				120984	141
				120985bx	142
				120986bx	142
				120987bx	142
				120988bx	143
				120989bx	143
				120990bx	143
				120991bx	143
				120992bx	143
				120993bx	143
				120994bx	143
				120995bx	143
				120996bx	143
				120997bx	143
				120999bx	137
				121100pr	168
				121101pr	168
				121102	152
				121103pr	168
				121104pr	168
				121105pr	168
				121106	168
				121107pr	168
				121108pr	168
				121109pr	168
				121110pr	168
				121111	155
				121113	155
				121114	155
				121115	155
				121116	155
				121117cs	155
				121118	155
				121119	155
				121126	155
				121127	156
				121128	156
				121129	171
				121130	171
				121131bx	154
				121132cs	154
				121133cs	154
				121134cs	154
				121135cs	154
				121136cs	154
				121138pk	76
				121139	63
				130101	71
				130101cs	71
				130103	71
				130103cs	71
				130105	71
				130105cs	71
				130107	71
				130107cs	71
				130109	71
				130109cs	71
				130111	71
				130111cs	71
				130112	71
				130112cs	71
				130113	71
				130114	71
				130115	71
				130116	71
				130118	71
				130119	71
				130120	71
				130121	71
				130122bx	71
				130123bx	71
				130125	71
				130125bx	71
				130126	71
				130127	71
				130128	71
				130129	71
				130130	71
				130131	71
				130202	67

ITEM #	PAGE				
130207.....	64	130312....	62– 63, 68	130516bx	74
130208.....	65	130312cs.....	68	130517bx	74
130209.....	62–63	130314.....	66, 69	130518bx	74
130210.....	62–63	130314cs.....	69	130519bx	74
130211.....	63	130321.....	68	130526bx	73
130212.....	63	130321cs.....	68	130527bx	73
130213.....	65	130322.....	63	130528bx	73
130214.....	64	130323bx	75	130529bx	73
130215.....	64	130325.....	63, 68	130530bx	73
130216.....	64	130325cs.....	68	130531bx	73
130217.....	64	130326.....	64–65	130532bx	73
130218.....	65	130327.....	64	130533bx	73
130219.....	65	130328.....	65, 68	130534bx	73
130220.....	65	130328cs.....	68	130535bx	73
130221.....	62– 63	130329.....	65	130536bx	73
130222.....	65	130330.....	65, 69	130537bx	73
130228.....	64	130330cs.....	69	130538bx	73
130229.....	67	130331.....	65, 69	130539bx	73
130230.....	62	130331cs.....	69	130540bx	73
130231.....	62	130332.....	65, 70	130541bx	73
130232.....	63	130332cs.....	70	130542bx	74
130233.....	64	130333.....	67	130543bx	73
130234.....	66	130334.....	69	130544bx	73
130235.....	66	130334cs.....	69	130545bx	73
130236.....	66	130335.....	67	130546bx	73
130301.....	70	130337.....	68	130547bx	73
130301cs.....	70	130337cs.....	68	130548bx	73
130302....	64– 65, 70	130401.....	66	130549bx	73
130302cs.....	70	130402.....	66	130550bx	73
130303.....	64, 70	130403.....	66	130551bx	73
130303cs.....	70	130405.....	67	130552bx	73
130304.....	64	130502bx	74	130553bx	73
130305.....	64, 69	130503bx	74	130554bx	73
130305cs.....	69	130504bx	74	130555bx	73
130306.....	64, 69	130505bx	74	130556bx	73
130306cs.....	69	130506bx	74	130557bx	73
130307.....	64, 69	130507bx	73	130558bx	73
130307cs.....	69	130508bx	73	130559bx	73
130311....	62– 63, 68	130514bx	74	130560bx	73
130311cs.....	68	130515bx	74	130561bx	73
				130562bx	73
				130563bx	73
				130564bx	74
				130565bx	74
				130566bx	74
				130567bx	74
				130568bx	74
				130569bx	74
				130570bx	74
				130571bx	74
				130572bx	74
				130573bx	74
				130574bx	74
				130575bx	74
				130576bx	74
				130577bx	74
				130578bx	74
				130579bx	74
				130580bx	74
				130581bx	74
				130582bx	74
				130583bx	74
				130584bx	74
				130601.....	77
				130602.....	77
				130603.....	77
				130604bx	75
				130605bx	75
				130606bx	75
				130607bx	75
				130608bx	75
				130609bx	75
				130610bx	75
				130611bx	75
				130612bx	76
				130615.....	77
				130616.....	77
				130617.....	77
				130618.....	77
				130619bx	76
				130620bx	76
				130621bx	76
				130623bx	76
				130624bx	76
				130637bx	76
				130638bx	77
				130639bx	75
				130640bx	75
				130641bx	75
				130642bx	75
				130643bx	75
				130644bx	75
				130645bx	75
				130646bx	75
				130647bx	76
				130648bx	76
				130649bx	76
				130650bx	76
				130651bx	76
				130652bx	76
				130653bx	76
				130654bx	76
				130655bx	76
				130656pk	77
				130657pk	77
				130658bx	77
				130659bx	77
				140101.....	58
				140102.....	58
				140202.....	57
				140303.....	55
				140306.....	56
				140307.....	56
				140308.....	56
				140309.....	56
				140310.....	56
				140311.....	56
				140312.....	56
				140313.....	56
				140314.....	130

Product Index (BY ITEM #)

ITEM #	PAGE				
140317.....	57	160111.....	203	160420.....	203
140318.....	55	160112.....	202	160421.....	207
140319.....	55	160113.....	202	160501.....	205
140320.....	57	160116.....	203	160502.....	205
140321.....	58	160201.....	206	160503.....	205
140322.....	60	160203.....	206	160601.....	207
140323.....	60	160204.....	206	160602.....	207
140324.....	60	160205.....	206	160603.....	207
140325.....	61	160206.....	206	160604.....	207
140326.....	61	160301.....	205	160605.....	207
140327.....	61	160302.....	205	160606.....	207
140328.....	54	160303.....	205	160607.....	207
140401.....	59	160304.....	205	160608.....	207
140403.....	59	160306.....	205	160609.....	207
140405.....	59	160307.....	205	160610.....	207
140406.....	130	160308.....	205	160611.....	207
140502.....	61	160309.....	205	160612.....	207
140503.....	61	160310.....	205	160613.....	207
140504.....	61	160311.....	205	160614.....	207
150102.....	200	160312.....	205	160615.....	207
150103.....	200	160313.....	205	160616.....	207
150104.....	199-201	160314.....	205	170108.....	173
150105.....	200	160401.....	204	170111.....	173
150106.....	199-201	160402.....	204	170112.....	173
150107.....	201	160403.....	204	170113.....	173
150109.....	199	160404.....	204	170116.....	173
150110.....	199-201	160405.....	204	170117.....	173
150111.....	201	160406.....	204	170118.....	174
150112.....	201	160407.....	203	170119.....	174
150113.....	201	160408.....	203	170120.....	174
160101.....	202	160409.....	203	170121.....	172
160102.....	202	160410.....	203	170123.....	172
160103.....	202	160411.....	207	170124.....	172
160104.....	202	160412.....	207	170125.....	172
160105.....	202	160413.....	207	170131.....	165
160106.....	202	160415.....	207	170132.....	165
160107.....	202	160416.....	207	170133.....	165
160108.....	202	160417.....	207	170134bx.....	164
160109.....	202	160418.....	204	170135bx.....	164
160110.....	202	160419.....	204	170136bx.....	164
				170137bx.....	164
				170138bx.....	164
				170139bx.....	164
				170140bx.....	164
				170141bx.....	164
				170142bx.....	164
				170143bx.....	164
				170144bx.....	164
				170145bx.....	164
				170146bx.....	164
				170147bx.....	164
				170148bx.....	164
				170149.....	163
				170150bx.....	164
				170151bx.....	164
				170152.....	172
				170153.....	173
				170154.....	173
				170155.....	173
				170156.....	174
				170157.....	174
				170160.....	176
				170161.....	176
				170162.....	176
				170163.....	176
				170164.....	176
				170165.....	176
				170166.....	176
				170168.....	176
				170169.....	176
				170172.....	174
				170201.....	166
				170202.....	166
				170203.....	166
				170204.....	167
				170205.....	166
				170206.....	167
				170207.....	166
				170219.....	167
				170406.....	177
				170407.....	177
				170408.....	177
				170409.....	177
				170410.....	177
				170411.....	177
				170412.....	177
				170413.....	177
				170414.....	177
				170415.....	177
				170416.....	177
				170417.....	177
				170418.....	177
				170419.....	177
				170420.....	177
				170421.....	177
				170422.....	177
				170423.....	155
				170426.....	155
				170427.....	155
				170503.....	169
				170504.....	169
				170505.....	169
				170506.....	169
				170507.....	169
				170508.....	169
				170509.....	169
				170510.....	169
				170511.....	169
				170512.....	169
				170513.....	169
				170601.....	168
				170602.....	168
				180101pk.....	191
				180102pk.....	191
				180103pk.....	191
				180105pk.....	191
				180106pk.....	191
				180107pk.....	191
				180108pk.....	191
				180109pk.....	191

ITEM #	PAGE				
180110pk	191	180604pk	179	180644	179
180111pk	191	180605pk	181	180645pk	179
180112pk	191	180606pk	179	180646	180
180113pk	191	180607pk	179	180647pk	179
180114pk	191	180608pk	179	180648	180
180115pk	191	180609pk	180	180649pk	180
180116pk	191	180610pk	180	180650	180
180117pk	191	180611pk	180	180651pk	180
180118pk	191	180612pk	180	180652	180
180119pk	191	180613pk	183	180653pk	180
180120pk	191	180614pk	183	180654	180
180121pk	191	180615pk	183	180655	180
180122pk	191	180616pk	183	180656pk	180
180123pk	191	180617pk	182	180657	181
180124pk	191	180618pk	182	180658pk	181
180301pk	190	180619pk	179	180659	181
180302pk	190	180620pk	180	180660pk	181
180306pk	190	180621pk	181	180661	182
180307pk	190	180622pk	179	180662pk	182
180308pk	190	180623pk	182	180663	182
180309	190	180624pk	181	180664pk	182
180310	190	180625pk	179	180665	182
180311	190	180626pk	181	180666pk	182
180312	190	180627pk	182	180667	182
180405pk	192	180628pk	181	180668pk	182
180406pk	192	180629pk	180	180669	183
180407pk	192	180630pk	183	180670pk	183
180408	192	180631pk	182	180672pk	183
180409	192	180632pk	183	180673	183
180410	192	180633pk	181	180674pk	183
180412	192	180634pk	179	180675	183
180413	192	180635pk	179	180676pk	183
180414	192	180636pk	179	180681	179
180415	192	180637pk	182	180682	179
180416	192	180638pk	181	180683pk	179
180417	192	180639pk	181	180685pk	179
180418	192	180640pk	182	180687pk	179
180419	192	180641pk	183	180690pk	179
180501	194	180642	179	180693pk	180
180603pk	183	180643pk	179	180694	180
				180695pk	180
				180696	181
				180697pk	181
				180698	181
				180699pk	181
				180703	190
				180807pk	189
				180808pk	186
				180809pk	186
				180810pk	186
				180811pk	187
				180812pk	188
				180813pk	189
				180814pk	188
				180815pk	186
				180816pk	187
				180817pk	187
				180818pk	186
				180819pk	189
				180822pk	188
				180823pk	188
				180824pk	188
				180825pk	188
				180826pk	188
				180827pk	188
				180828pk	188
				180829	190
				180830pk	187
				180831pk	187
				180832pk	187
				180833pk	187
				180834pk	187
				180835	187, 190
				180836	190
				180838pk	186
				180839pk	186
				180840pk	186
				180841pk	186
				180842pk	186
				180843pk	186
				180844pk	186
				180845pk	186
				180846pk	186
				180847pk	186
				180848pk	186
				180849pk	186
				180850pk	186
				180851pk	186
				180852pk	186
				180853pk	186
				180854pk	186
				180855pk	187
				180856pk	187
				180857pk	187
				180858pk	187
				180859pk	187
				180860pk	187
				180861pk	187
				180862pk	187
				180863pk	187
				180864pk	187
				180865pk	187
				180866pk	187
				180867pk	187
				180868pk	187
				180869pk	187
				180870pk	188
				180871pk	188
				180872pk	188
				180873pk	188
				180874pk	188
				180875pk	188
				180876pk	188
				180877pk	188
				180878pk	188
				180880pk	188
				180881	190
				180882pk	188
				180883pk	188
				180884pk	188

Product Index (BY ITEM #)

ITEM #	PAGE				
180885pk	188	181417pk	182	181513pk	193
180886pk	188	181418	182	181514	47
180887pk	189	181420	183	181515	193
180888pk	189	181421pk	183	181601	184
180889pk	189	181422	183	181602	184
180890pk	189	181423pk	183	181603	184
180891pk	189	181424pk	179	181604	184
180892pk	189	181425pk	179	181605	184
180893pk	189	181426pk	179	181606	184
180894pk	189	181427pk	179	181607	184
180895pk	189	181429pk	180	181608	184
180896pk	189	181430pk	180	181609	184
180897pk	189	181431pk	180	181610	184
180898pk	189	181432pk	180	181611	184
180899pk	189	181433pk	180	181612	184
180901pk	192	181434pk	180	181613	184
180902pk	186	181435pk	181	181614	184
180903pk	186	181436pk	182	181615	184
181201pk	185	181437pk	182	181616	184
181202pk	185	181438pk	182	181617	184
181203pk	185	181439pk	182	181618	184
181204pk	185	181440pk	182	181619	184
181205pk	185	181441pk	182	181620	184
181207pk	185	181442pk	182	181621	184
181208pk	185	181443pk	183	181622	184
181209pk	185	181444pk	183	181701pk	189
181210pk	185	181445pk	183	181702pk	189
181211pk	185	181446pk	183	181703pk	189
181212pk	185	181501pk	193	181704pk	189
181301	178	181502pk	193	181705pk	189
181401	181	181503pk	193	181706pk	189
181403	181	181504pk	193	181707bx	189
181406pk	181	181505pk	193	181708bx	193
181408pk	181	181506pk	193	181709bx	193
181410pk	181	181507pk	193	181710bx	193
181412pk	181	181508pk	193	181801	195
181413	181	181509pk	193	181802	195
181414pk	181	181510pk	193	181803	195
181415	182	181511pk	193	181804	194
181416pk	182	181512pk	193	181805	194
				181806	194
				181807	194
				181808	194
				181809	195
				181810	195
				181811	195
				181812	196
				181813	195
				181814	196
				181816	185
				190101	101
				190102	101
				190103	101
				190106	102, 131
				190107	102
				190110	102
				190111	102
				190201	93
				190202	93
				190203	95
				190204	95
				190205	95
				190206	96
				190207	93
				190208	95
				190209	95
				190210	97
				190211	97
				190212	98
				190213	98
				190214	95
				190215	95
				190216	106
				190217	106
				190218	103
				190301	96
				190302	96
				190303	92
				190304	92
				190305	92
				190306	92
				190307	95
				190308	96
				190309	96
				190310	96
				190311	96
				190312	110
				190313	109
				190315	105
				190316	96
				190317	104
				190318	104
				190319	104
				190320	104
				190321	108
				190322	109
				190323	109
				190324	107
				190325	108
				190326	107
				190327	110
				190328	110
				190329	99
				190330	100
				190331	100
				190332	100
				190333	100
				190334	100
				190335	100
				190336	100
				190337	97
				190338	98
				190339	103
				190340	103
				190341	104
				190342	104
				190343	107
				190344	107
				190345	105
				190346	93

ITEM #	PAGE				
190347.....	93	190702.....	101	200310bx	214
190348.....	93	190802.....	96	200311bx	214
190349.....	93	190805.....	98	200312cs.....	216
190350.....	93	190806.....	92	200313cs.....	216
190351.....	108	190807.....	92	200314cs.....	216
190501.....	90	190808.....	92	200315cs.....	216
190502.....	91	190809.....	92	200316cs.....	216
190503.....	90- 91	190810.....	92	200317cs.....	216
190505.....	90	190811.....	102, 131	200318cs.....	216
190506.....	91	190812.....	102	200319cs.....	216
190507.....	91	190901.....	111	200700bx	219
190508.....	99	190902.....	111, 132	200701bx	219
190509.....	91	190903.....	111, 132	200703bx	219
190510.....	91	190904.....	90	200704bx	219
190511.....	91	190906.....	111	200705bx	219
190512.....	125	190907.....	111	200706bx	219
190513.....	125	190908.....	111	200707bx	219
190514.....	125	190909.....	111, 132	200708bx	219
190515.....	125	192001.....	133	200709bx	219
190516.....	125	192002.....	133	200710bx	219
190517.....	103	192003.....	133	200711bx	219
190518.....	103	192004.....	133	200712bx	219
190601.....	19	200102bx	213	200713bx	219
190602.....	19	200103bx	213	200714.....	64
190603.....	19	200104bx	213	200715bx	69
190605.....	102	200105bx	213	200716bx	216
190606.....	102	200106bx	213	200717bx	216
190607.....	102	200107bx	213	200718bx	216
190608.....	94, 133	200108bx	212	200719bx	216
190609.....	94	200109bx	212	200720bx	216
190613.....	94, 133	200110bx	212	200721bx	216
190614.....	94	200111bx	212	200722bx	216
190631.....	99	200112bx	212	200809bx	213
190632.....	97	200113bx	212	200812bx	212
190633.....	97	200303bx	212	200822bx	212
190634.....	101, 132	200304bx	212	200823bx	212
190635.....	96, 132	200305bx	212	200824bx	212
190636.....	95	200306bx	215	200825bx	213
190637.....	95	200307bx	215	200826bx	213
190701.....	98	200309bx	212	200827bx	213
				200828bx	213
				200831bx	216
				200832bx	216
				200834bx	216
				200840.....	214
				200841bx	214
				200842bx ..	212-214
				200843bx ..	213-214
				200844bx ..	213-214
				200845bx ..	213-214
				200846bx ..	213-214
				200847bx ..	212-214
				200848bx ..	213-214
				200849bx ..	213-214
				200850bx ..	213-214
				200851bx	214
				200852bx	214
				200853bx	214
				200854bx	214
				200855bx	214
				200856bx	214
				200857bx	214
				200858bx	214
				200859bx	214
				200860bx	214
				200864bx	217
				200865bx	217
				200866bx	217
				200867bx	217
				200869bx	217
				200870bx	217
				200871bx	217
				200873bx	217
				200874bx	217
				200875bx	217
				200876bx	217
				200877bx	217
				200878bx	217
				200879bx	217
				200880bx	217
				200881bx	217
				200882bx	217
				200883bx	217
				200884bx	217
				200885bx	217
				200886bx	217
				200887bx	217
				200888bx	219
				200889bx	219
				200890bx	219
				200891bx	219
				200892bx	219
				200893bx	219
				200894bx	219
				200895bx	219
				200896bx	219
				200897bx	219
				200898bx	217
				200899bx	219
				200913bx	215
				200914bx	215
				200915bx	215
				200916bx	215
				200917bx	215
				200918bx	212
				200919bx	212
				200920bx	212
				200921bx	212
				200922bx	215
				200923bx	215
				200924bx	215
				200925bx	215
				200926bx	215
				200927bx	215
				200928bx	215
				200929bx	215
				200930bx	212
				200931bx	212
				200932bx	212
				200933bx	212

Product Index (BY ITEM #)

ITEM #	PAGE				
200934bx	212	201008bx	213	201210bx	72
200935bx	215	201009bx	214	201211bx	72
200937bx	215	201010bx	214	201212bx	72
200938bx	215	201011bx	214	201213bx	72
200939bx	215	201012bx	214	201215bx	72
200940bx	215	201015bx	217	201216bx	72
200941bx	215	201016bx	217	201217bx	72
200942bx	213	201017bx	217	201218bx	72
200943bx	213	201101bx	218	201219bx	72
200944bx	213	201102bx	218	201220bx	72
200945bx	213	201103bx	218	201221bx	72
200946bx	213	201104bx	218	201222bx	72
200947	63, 66	201105bx	218	201223bx	72
200948bx	212	201106bx	218	201224bx	72
200950bx	216	201107bx	218	201225bx	72
200951bx	216	201108bx	218	201226bx	72
200952bx	216	201109bx	218	201227bx	72
200953bx	216	201110bx	218	201228bx	72
200954bx	216	201111bx	218	210201	126
200955bx	216	201112bx	218	210202	126
200956bx	216	201113bx	218	210203	126
200957bx	216	201114bx	218	210204	126
200958bx	216	201115bx	218	210205	126
200959bx	216	201116bx	218	210206	126
200960bx	216	201117bx	218	210309	127
200967bx	213	201118bx	218	210310	127
200968bx	213	201119bx	218	210311	127
200969bx	213	201120bx	218	210312	127
200970bx	213	201121bx	218	210313	127
200971bx	213	201122bx	218	210314	127
200972bx	213	201123bx	218	210401	126
200973bx	213	201201bx	72	210402	126
200974bx	213	201202bx	72	210403	127
201001bx	213	201203bx	72	210404	127
201002bx	213	201204bx	72	210405	127
201003bx	212	201205bx	72	210406	127
201004bx	215	201206bx	72	220102	10
201005bx	215	201207bx	72	220110	14, 131
201006bx	215	201208bx	72	220111	14, 131
201007bx	213	201209bx	72	220112	14, 131
				220201	15
				220202	8
				220204	9
				220205	8
				220301	9
				220302	9
				220303	9
				220304	9
				220401	9
				220402	15
				220501	8
				220502	9
				220601	13
				220602	13
				220603	13
				220604	13
				220605	13
				220606	13
				220607	11
				220608	11
				220609	11
				220610	11
				220611	13
				220612	11
				220613	11
				220614	11
				220615	13
				220616	11
				220617	11
				220621	13
				220622	12
				220623	12
				220624	12
				220625	12
				220626	12
				220627	12
				220628	12
				220629	12
				220630	12
				220640	12
				220641	12
				220642	10
				220643	15
				220644	131
				220653	23
				230101	27
				230109	26
				230110	27
				230111	27
				230112	27
				230115	24
				230116	24
				230117	24
				230118	24
				230119	24
				230120	24
				230121	24
				230122	24
				230123	24
				230124	24
				230126	24
				230127	24
				230130	25
				230201	27
				230202	27
				230203	27
				230207	26
				230208	26
				230214	26
				230215	26
				230216	26
				230217	26
				230218	26
				230219	26
				230220	26
				230221	26
				230222	26
				230223	25
				230224	24
				230225	24

ITEM #	PAGE				
230226.....	24	230316.....	29	230508.....	36
230227.....	24	230317.....	29	230512.....	37
230228.....	24	230318.....	29	230513.....	36
230229.....	24	230319.....	29	230514.....	36
230231.....	25	230320.....	29	230517.....	37
230233pk	33	230404.....	30	230518.....	37
230234.....	27	230422.....	32	230519.....	37
230235.....	27	230423.....	32	230520.....	37
230236.....	27	230424.....	32	230521.....	36
230237.....	27	230425.....	33	230522.....	36
230238.....	27	230426.....	33	230601.....	39
230239.....	27	230427.....	33	230602.....	38
230240.....	27	230428.....	33	230603.....	38
230242pk	33	230429.....	33	230604.....	39
230243pk	33	230430.....	33	230605.....	39
230244pk	33	230431.....	33	230619.....	38
230245pk	33	230434.....	33	230620.....	38
230246bx	33	230435.....	32	230623.....	39
230247.....	28	230441bg.....	32	230624.....	38
230248.....	28	230451.....	34	230625.....	38
230249.....	28	230453.....	34	230626.....	38
230251.....	27	230456.....	34	230627.....	39
230252.....	27	230457.....	34	230628.....	39
230253.....	27	230458.....	34	230629.....	39
230254.....	27	230459.....	34	230630.....	38
230255.....	27	230460.....	34	230631.....	38
230301.....	29	230461.....	34	230632.....	38
230302.....	29	230462.....	34	230633.....	40
230304.....	29	230463.....	35	230634.....	40
230305.....	29	230464.....	35	230635.....	40
230306.....	29	230465.....	35	230636.....	40
230307.....	29	230466.....	35	230637.....	40
230308.....	29	230467.....	35	230644.....	39
230309.....	29	230468.....	35	230651.....	40
230310.....	29	230469.....	35	230652.....	25
230311.....	29	230470.....	35	230701.....	41
230312.....	29	230471.....	35	230702.....	41
230313.....	29	230475.....	32	230703.....	41
230314.....	29	230476.....	32	230704bx	41
230315.....	29	230506.....	36	230704cs.....	41
				230705bx	41
				230705cs.....	41
				230706.....	41
				230707.....	41
				230708.....	41
				230709.....	41
				230711.....	42
				230712bx	42
				230713.....	42
				230714.....	42
				230715bx	42
				230716.....	42
				230717.....	41
				230718bx	41
				230719.....	42
				230720.....	42
				230721.....	42
				230722bx	42
				230723bx	42
				230724.....	42
				230725bx	42
				230727.....	42
				230728.....	42
				230729.....	41
				230730.....	41
				230801.....	43
				230802bx	43
				230803bx	43
				230805.....	44
				230806.....	44
				230808.....	44
				230809.....	44
				230810.....	44
				230811.....	44
				230812.....	43
				230813.....	43
				230814.....	43
				230815.....	44
				230816.....	47
				230820.....	45
				250303.....	223
				250304.....	223
				250305.....	223
				250306.....	223
				250307.....	223
				250308.....	223
				250334.....	223
				260101.....	112
				260107.....	112
				260109.....	112
				260110.....	112
				260111.....	113
				260201.....	114
				260202.....	114
				260205.....	113
				260211.....	114
				260301.....	118
				260302.....	118
				260303.....	118
				260304.....	118
				260305.....	119
				260306.....	119
				260308.....	119
				260310.....	117
				260311.....	117
				260401.....	121
				260402.....	121
				260406.....	122
				260501.....	120
				260505.....	120
				260602.....	122
				260603.....	122
				260604.....	123
				260606.....	123
				260612.....	124
				260613.....	123
				260621.....	116
				260626.....	119
				260627.....	123
				260628.....	113

Product Index (BY INDEX)

ITEM #	PAGE								
260630.....	116	290125rl	85	290170rl	84	290219rl	81	290720bg.....	80
260633.....	116	290127rl	85	290171rl	85	290220rl	81	290721pk.....	78
260634.....	116	290128rl	87	290172rl	85	290339rl	83	290722bx.....	80
260638.....	112	290129rl	87	290175rl	85	290340rl	83	290723bx.....	80
260639.....	113	290130rl	87	290176rl	85	290441rl	79	290724bx.....	80
260640.....	113	290131rl	87	290177rl	84	290442rl	79	290725bx.....	80
260641.....	114	290132rl	87	290178rl	85	290443rl	79	290726bx.....	80
260642.....	114	290133rl	87	290179rl	85	290444rl	79	270727bx.....	80
260643.....	115	290134rl	87	290180rl	85	290535rl	89	290728bx.....	80
260644.....	115	290135rl	87	290181rl	85	290536rl	89	290729rl	78
260645.....	115	290136rl	87	290182rl	85	290537rl	88	290730rl	78
260646.....	115	290137rl	87	290183rl	86	290538rl	88	290731rl	78
260647.....	115	290138rl	87	290184rl	86	290545rl	88	290732rl	78
260648.....	116	290139rl	88	290185rl	86	290546rl	88	290733rl	78
260649.....	117	290140rl	88	290186rl	86	290554cs.....	88	290734rl	78
260650.....	120	290141rl	88	290187rl	86	290591rl	89	290735rl	78
260651.....	120	290145rl	88	290188rl	86	290592rl	89	290736pk.....	78
260652.....	120	290155rl	83	290189rl	86	290593rl	89	300105bx.....	140
260653.....	121	290156rl	83	290190rl	86	290594rl	89	300115.....	35
260654.....	121	290157rl	83	290191rl	86	290595rl	89	300117.....	165
260655.....	122	290158rl	83	290207pk.....	80	290596rl	89	300121.....	165
260656.....	124	290159rl	83	290208pk.....	80	290597rl	89	300202.....	211
270101.....	210	290160rl	83	290209pk.....	80	290598rl	89	300203.....	211
270102.....	210	290161rl	83	290210.....	88	290599rl	89	300204.....	211
270106.....	210	290162pk.....	83	290211.....	88	290640.....	25	300205.....	211
290101rl	79	290163rl	83	290212rl	80	290647pk.....	81	980107.....	10
290102rl	79	290164rl	84	290213rl	80	290648pk.....	81		
290103rl	79	290165rl	84	290214rl	81	290649pk.....	81		
290104rl	79	290166rl	84	290215rl	81	290650rl	82		
290105rl	83	290167rl	84	290216pk.....	80	290651kt.....	82		
290106rl	83	290168rl	84	290217pk.....	81	290652pk.....	82		
290123rl	84	290169rl	84	290218rl	81	290653pk.....	82		

Product Index (BY NAME)



A

Alaris 8000/8015 Medley62
Alaris 8100 Infusion..... 62–63
Alaris 8100 Syringe63
Alaris 8120 PCA63
Alaris 8300 ETCO263
ABD Pad140, 149
ACCUVEIN..... 128
Adherent Wrap..... 141
Adhesive Remover..... 138
Admission Kit 153
AED Manikins & Trainers22
AED Simulators.....19
AEDs..... 16–18
Aerosol Mask..... 202
Air Flowmeter 223
Airway Suction Trainer..... 100
Alaris Infusion Pumps.....62–63, 65
Alcohol Abuse Models.....120–121
Alcohol Dispenser 136
Alcohol Prep Pad 136
Alcohol, Isopropyl 136
Alginate Dressing.....142–143
Ammonia Inhalant..... 156
Ampule, Chloraprep 137
Ampules – Practice Meds 191
Applicator, Chloraprep..... 137
Auscultation Trainer 102–103, 131
Auscultation Trainer, PAT 131
Auscultation Trainer, Pediatric..... 131
Auscultation Trainer, Sam II 131

B

Baby Hippy Manikin92
Baby Oil..... 151
Baby Powder 151

Baby Wipes..... 146
Bandage Shears 155
Bandages 138
Bathing Package 177
Batteries33
Baxter Infusion Pumps
(Reconditioned)..... 64
Baxter Syringe Pumps
(Reconditioned)..... 66
BBraun Infusion Pumps
(Reconditioned)..... 65
Bed Cradle And Foot Support..... 171
Bedside Cabinet.....61
Berman Oral Airways 207
Bibs..... 154
Biohazard Bag..... 155
Birthing Station Simulator92
Blade Sets and Battery Handles ... 207
Blood Collection Sets..... 75–76
Blood Culture Device75
Blood Drawing Chair 173
Blood Pressure Cuffs..... 24–26
Blood Pressure Trainers99
BP Sim28
BP Simulator28
Breast Examination Simulator.....93
Breast Model 116
BSE Model..... 114
BTUSA Manikins97–98
Bubble Humidifier..... 203
Buck Hammer44
Bulb Syringe..... 151
Burn Sheet 155
Burn Simulation Kit..... 108

Butterfly Closures..... 138
Butterfly Infusion Sets76

C

Cadaver Bag..... 155
CADD Infusion Pumps (New).....67
Camera , WiFi, Bio Vid50
Canes 170
Canine IV Leg.....98
Cannula 203
Cape, Exam..... 153
Caps 145
CARDIONICS 101
Cardiovascular Disease Models.... 112
Carefusion Infusion Pumps ..62–63, 65

CARTS

..... 12–20
Childrens Storage 10
Computer/Medication Cart .. 14, 131
Crash Carts.....4– 5, 11
ECG.....23
Emergency Carts8–9
Hamper..... 13
Hyperthermia Carts 8
Isolation 9
Manikin Storage..... 13
Medication Carts 8–9, 131
Metro Access Point of Care 14
Mobile Storage Racks..... 11
Pediatric Carts 9
PPE Dispensing Unit..... 12
Shelving With Bins 13
Supply Shelf 13
White Board..... 10
Wire Utility Racks..... 11
Catheter Insertion Tray..... 158

Product Index (BY NAME)

Catheter Plug And Tube Tip	Cuffalator	203	Scales.....	36–37
Protector.....	Cups	154	Sim BP.....	28
Catheter/Syringe Adapter.....			Stethoscopes	38–40
Cavicide.....	D		Testing Supplies.....	43
Central Line Dressing Trays	DEFIBRILLATORS	21–28	Thermometers	41–42
Change	AEDs.....	18	Vision Testing	34
159–162	Customized.....	16	Diagnostics Sets.....	32
Central Venous Cannulation	ECGs/ECG Trainers.....	20–22	Diapers, Adult	152
Simulator	ECG Rolling Stands	23	Differential Counters	48
98	Reconditioned	17	Digital Blood Pressure Monitors .	26, 34
Centrifuge	Simulators	19	Disinfectant	148
48	Dental Bibs.....	154	Dispenser, Sanitizer.....	147
Cervical/Effacement Dilatation	Denture Brush.....	150	Dispenser, Surgical Scrub	147
Simulators	Denture Cup	150	Doppler	29
92	Denture Tablets	150	Drain Sponges	140
Chairs.....	Deodorant	151	Drapes	154
173	Dextrose Solutions	71	Drawstring Bag.....	153
Chemo Spill Kit.....	Diabetes Display	113	Dressing Change Tray....	5, 7, 159–160
163	Diabetic Foot Model.....	113	Drug Abuse Display	121–122
Chest Tube Manikin.....	Diagnostic Systems.....	130	DYMO–Compatible Labels.....	80
100	DIAGNOSTICS	29–37	Dyna Stopper	155
Childbirth Model	Aneroid BP/Kits	24–25		
116	Blood Pressure Digital	26	E	
Chloraprep.....	Blood Pressure Mobile.....	27	Ear Exam Trainers.....	93–94, 133
137	Centrifuges, Incubators, Counters	48	ECG Placement Trainer.....	22
Cholesterol Display.....	Diagnostic Tools.....	44	ECG Simulators	19, 21
113	Doppler.....	29	ECG Stands.....	23
Cohesive Bandages.....	Glucose Testing	45	ECG Trainer Manikin	22
141	Glo–Products	47	ECGs.....	20–21
Cold Pack	Integrated Diagnostics	30–31	Edema Trainer	107
152	Lancets	46	Elastic Bandages.....	141
Colorectal Polyp Model.....	Microscopes	49	Electrocardiograph	20–21
112	Ophthalmoscopes.....	32–33	Electronic Thermometers	41
Comb	Otosopes	32–33	Element Treatment Table	172
149	Penlights.....	35	Emergency Blanket.....	155
Combine Pads.....				
140, 149				
Computer Cart				
131				
Condom Training Model				
115				
Cot Sheet				
155				
Cotton Applicator				
135				
Cotton Balls				
135				
Coveralls				
145				
CPR Dog Manikin.....				
101				
CPR Manikin.....				
101				
CPR Pocket Resuscitator				
202				
CPR Shields				
202				
CPR Simulator				
132				
Crutches				
170				

Emery Boards	149	Glove Box Dispensers.....	176	Hydrocolloid Dressing	143
Emesis Basin	151	GLOVES	38–47	Hydrogel Sheets.....	143
Enemas	152	Gloves Latex	50	Hydrogen Peroxide	136
Enteral Feeding Pump	166	Gloves Vinyl	53	Hypodermic Needles	216
Exam Cape	153	Gloves, Chemo.....	53		
Exam Tables.....	172	Gloves, High Risk Latex	50	I	
Extension Sets	68–69	Gloves, Nitrile	52	Immunizations Display	113
Eye Charts.....	34	Gloves, Surgical	53	Incubator	48
Eye Occluder/Protector	34	Glucose Monitoring	45	Infant Linen Package	177
Eyepads.....	140	Gooseneck Lamp.....	172	Infant Warmers	60
F		Gowns	145, 153	Infection Control Kit.....	211
Face Mask.....	144, 202	H		Infection Prevention	
Face Shield.....	144	Hairbrush	149	Organizer/Station	176
Fat Analyzer	37	Halsted Mosquito Forceps	165	Infinity Automatic Coding Starter Kit	45
Feeding Pumps/Sets.....	166–167	Hand Hygiene.....	81	Inflatable Cushion Ring	152
Fetal Health Model	117	HCG Combo Test	43	Influenza Quickvue Test.....	43
Fingernail Clippers	149	HEADWALLS	220–223	Infrared Thermometer	41–42
First Aid Kits.....	156	Headwall Accessories.....	223	INFUSION	62–77
Flo–Gard 6301.....	64	Heart Disease Models.....	112	Infusion Pumps	62–65
Floor Scale	37	Hematocrit.....	48	Syringe Pumps.....	66
Flu Syringe Tray.....	214	Hemocult Test Cards.....	43	New Pumps	67
Foley Catheter Kits.....	4, 6, 157–158	Hemodialysis Practice Arm.....	103	Infusion Sets	68
Foot Stools.....	173	Hemostatic Forceps	165	IV Solutions	71
G		HIPAA–Compliant Sign–in Sheet	79	IV Catheters.....	72–74
Gait/Transfer Belts.....	171	Hospira Infusion Pumps	64–65	Blood Collection	75–77
Gastrocult Tests	43	HOSPITAL BEDS	54–61	Injection Simulators	95–97
Gauze, Rolls, Sponges.....	139–140	Accessories	61	Injection Trainers	95, 132
Gemstar Pumps	65, 70	Birthing	58	Instant Packs	155
Genius 2 Tympanic Thermometer	41	Hill Rom Bed Package	54	Instrument Tray	165
Geratherm Glass Thermometer	42	ICU	57	Insulin Injection Training Kit	211
Geri Complete Manikin	90	Infant Warmers.....	60	Insulin Syringes	212–219
Glasses.....	144	Med/Surg	55	Integrated Diagnostic Systems..	30–31
GLO Products.....	47	Multi–Position	56	Iodine Remover Pad	137
		Stretchers.....	59	Irrigation Tray	5, 7
				Ishihara Test Chart	34

Product Index (BY NAME)

Isolation Gown	145
IV Catheters	72–74
IV Poles	174
IV Solutions	71
IV Therapy Kit	210
IV Trainers	91, 96–98
IVAC Signature Gold	65

K

Kangaroo 924 Feeding Pump	166
Kangaroo ePump	166
Kangaroo Joey Pump	166
Kangaroo Pump Sets	166–167

(Continued)

Kelly Forceps	165
Kendall Syringes & Needles	216
Keri Nursing Skills Manikins	91
Kick Bucket	165
Krinkle Gauze	140

L

Lab Chair	173
Lab Jackets	145

LABELS

Admissions	78
Allergy	79
Biohazard Warning	82
Change Minder	83
Clear Label Protector	88
Dymo Compatible	81
Flu	83
General Office	81
Hand Hygiene	81
Infection	81–82
IV	84–85
Kids Stickers	86–87

Latex Allergy Alert	79
Nursing Kits	83–88
Patient Charge System	83
Pharmacy	88–89
Precautions Signs Kit	82
Visitor Pass Book	79

Lamp	172
Lancets	46
Laparoscopy Surgical Tray	163
Legacy Infusion Pump	67
Lifecare PCA 3	64
Linen Package	177
Lister Bandage Scissors	165
Littmann Stethoscopes	40
Long Term Care Card	194
Lotion	151
Lubricating Jelly	163
Lysol	148

M

MANIKINS	90–111
Airway	100
Auscultation	102–103
Blood Pressure	99
CPR	101
Dialysis	103
Edema Trainer	107
Examination	93
Infant, Birthing	92

MANIKINS (continued)

Injection	95
IV Trainers	96–98
Ostomy	110
Otosim	94
Patient Care	90–91
Sim Leggings	111

Stump Bandaging	109
Suture Training	104
Ulcer, Burns	108
Wound Care	105–106
Masks, Exam	144
Mattress	61
McIntosh Blades	207
McKesson Syringes & Needles	217
Medfusion Pumps	66–67

MEDIA

Alcohol	120–121
Drugs	121–122
Health	112–113
Nutrition	122–125
Pregnancy/Childcare	115–117
Tobacco	118–120
Women/Men's Health	114

MEDICAL SHIPMENT PRODUCTS

Medicine Cups	154
Medihoney	143
Mepitac	142
Metricide	148
Metro Crash Cart	15
Microscope WiFi Cam	50
Microscope Accessories	50
Microscopes	49
Miller Blades	207
Mobile Sphygomomanometer ..	27–28
Mobile Diagnostic Station	28

MONITORS

Vital Sign Monitors	126–127
Mosquito Forceps	165
Moulage	133
Multi Sample Luer Adapter (Sterile) ..	76
Multistix 10 SG Test	43

N			
NaCl Solutions.....	71	PAP Test Display	114
Nail File	149	Paper Souffle Cup	154
Nail Polish Remover	149	PATIENT CARE	134–171
Negative Pressure Wound Therapy	107	Adhesive Bandages	138
NEW PRODUCTS	128–133	Advanced Wound Care	142–143
Newborn Multi–Stripe Cap & White		Ambulatory.....	170–171
Booties.....	177	Central Line Dressing Change	
Non–Rebreathers.....	202	Trays.....	159–162
Nursing Kits	208–211	Disinfectants.....	148
Nutrition Displays	123–125	Elastic Bandages & Cohesives....	141
		Feeding Pumps & Sets.....	166
		First Aid Kits.....	156
		First Aid, EMS	155
		Foley Catheter Kits	157–159
		Gauze.....	139–140
		Hand Sanitizers	147
		Kits	163
		Medical Tape.....	134
		Patient Lifts	169
		Personal Care	149–154
		Personal Protection	144–145
		Scalpels, Scissors, Forceps	165
		SCDs.....	168
		Surgical.....	164
		Swabs & Prep	135–137
		Wipes, Soap.....	146
		Patient Drawstring Bag	153
		Patient Lifts	169
		Patient Monitors.....	126–127
		PATIENT ROOM	172–177
		Blood Draw Chairs, Stools	173
		Dispensers.....	176
		Exam Tables.....	172
		IV Poles, Screens	174
		Linens	177
		Sharps Containers.....	175
		PDI Removal Pads	137
		Peak Flow Meter.....	205
		Pediatric Lumbar Puncture	
		Simulator	98
		Pediatric Stethoscope	38
		Pen Light.....	35
		Perineum Wash.....	152
		Peritoneal Dialysis Simulator.....	103
		Petrolatum Jelly	151
		Phlebotomy Kit.....	210
		Phlebotomy Plastic Container.....	175
		Plum A+.....	64
		Plum XL Infusion Pump.....	65
		Polybag With Face Shield	202
		Polyskin.....	142
		PRACTICE MEDS	178–196
		Ambulance Kits	196
		Capsule Variety Packs	195
		Capsules.....	179–183
		Crash Cart Kits	196
		Emergency Training Kit.....	196
		Epi Pen	193
		Flavors	184
		Gels	193
		Heparin Pack	190
		Insulin Packs	190
		Liquid Variety Packs	195
		Lotion	193
		Measles, Mumps, Rubella	190
		Nasal Spray	193
		Nebulizer	193
		Ointment	193
		Ophthalmic Solution	193
		Otic Solution.....	193
		Prefilled Syringes	185
O			
Obstetrical Kit	163		
Ophthalmoscopes	32–33		
OphthoSim.....	94, 133		
Oral Airways Berman Type	207		
Oral Swabsticks.....	150		
Orange Sticks	149		
Osteoporosis Display	113		
Ostomy Care Model	110		
Ostomy Kit	211		
Otoscope Integrated Diagnostic			
System.....	30		
Otoscope/Ophthalmoscope Sets	32		
Otosopes	32–33		
OTOSIM.....	194, 33		
Outlook 100, BBraun Pump	65		
Overbed Light Fixtures	223		
Overbed Table.....	61		
Oxygen Flowmeter	223		
Oxygen Tubing.....	203		
P			
Packing Strips	142		
Panty Liners	152		

Product Index (BY NAME)

Tablet Variety Packs	194	Suction Catheters, Peak Flow ...	205	Skin & Vein Replacement Kit	96
Training Liquids	190–192	Resuscitation Devices	202	Skin Prep Dressing	138
Vial Packs	190	Ringers Solution	71	Skinfold Caliper	44
Vials	186–189	Room Divider	174	Sling (for Lifts)	169
Vitamin Pack	190			Slipper Socks	153
Suppositories	193	S		Smiths Syringe Pumps	
Preemie Simulator	92	Safety Glasses	144	(Reconditioned)	66
Pregnancy Simulator	117	SAM – Auscultation Trainer	102	Smiths Syringes & Needles	218
Prep Pads	136	Sani-Cloth	148	Smoking Consequence Display ...	118
Pressure Sore/Wound Measuring		Sanitizers	147	Soap	146
Device	44	Scales	36	Souffle Cup	154
Pressure Ulcer Model	108	Scalp Vein Butterfly Sets	76	Special Needs Infant Manikins	92
Prostate Cancer Display	114	Scalpels	164	Sphygmomanometers	24–26
Protective Glasses	144	SCDs	168	Spinal Injection Simulator	96
Pulse Oximeters	206	Scissors	165	Spinal Needles	77
Pump Sets	166–167	Screen, 3– Panels	174	Spirometer	205
PYXIS® 889	198–201	Scrub Solution/Brush	137	Splints	155
Auxiliary Unit	200	Secondary Sets	68– 69	Sponge Bowl	165
Console & Cabinet	200	Section Catheter	205	Staples Removal Kit	162
Direct Thermal Paper Rolls	88	Secure Ties	204	Starter Kit – Practice Meds	185
Medstation 2000 , 2–Drawer	201	Self Adherent Wrap	141	STDs Display	115
Medstation 4000 , 4–Drawer	200	Sensi Wrap	141	Sterile Water	71
Practice Starter Meds	178	Sharps Containers	175	Stethoscopes	38–40
Premium Package	199	Shave Prep Tray	162	Stools	173
Service Agreement	199	Shaving Cream	151	Straws	150
Workstation	201	Shears	155	Strep–A Test	43
		Sheets, Infant Woven Fitted	177	Stretch Bandages	140
R		Shelving, Antimicrobial	15	Stretchers	59, 130
Reclining Chair With Table	173	Shelving, Steel & Polymer	131		
Rescue Blanket	155	Shelving, Wire	11–12	STUDENT KITS	208–211
RESPIRATORY	202–207	Shiley Trach	203	Fully Customized	208–209
Accessories	203	Shoe Cover	145	Pre–Made Kits	210
Airways	206	Silicone Tape	142	Kits	211
Masks, CPR	202	SimLeggings	111, 132	Student Protection Kit	211
Pulse Oximeters	205	Sim Obesity Suit	111		
Tracheostomy	203–204			(Continued)	

Product Index (BY NAME)

Stump Bandaging 109
 SUB Q Simulator.....95
 Suction Canister 223
 Suction Catheter Kits 205
 Sundry Jars..... 135
 Sure Temp Thermometer41
 Surgical Blades 164
 Surgical Caps/Gowns 145
 Surgical Sally 105
 Surgical Scrub 147
 Suture Removal Kit 162
 Suture Trainers 104
 Swabstick, Chloraprep 137
 Swabstick, Simulated 4,7
 Swabsticks 4, 7, 135–137, 150
 Swabsticks, Lemon 150
SYRINGES/NEEDLES..... 212–219
 BD..... 212–213
 Bak'Snap 214
 Exel..... 215
 Kendall 216
 McKesson..... 217
 Smiths..... 218
 Terumo 219
 Syringe Adapter 159
 Syringe Allergy Tray..... 214
 Syringe Pumps66

T

Table Paper..... 154
 Tape 134
 Tape Measure44
 Taylor Percussion Hammer.....44
 TB Syringes.....213–214, 218
 TB Testing Arm95
 Teaching Scope38
 Tegaderm 142
 Telfa 139
 Tempa-Dot42
 Terumo Syringes & Needles..... 219
 Testicular Cancer Display 114
 Testicular Exam Simulator.....93
 Thermal Blanket..... 177
 Thermometers41–42
 Thermoscan.....41
 Tobacco Hazards 118–120
 Toothbrush..... 150
 Toothpaste..... 150
 Tourniquets77
 Towel Drapes..... 154
 Towelettes 146
 Tracheostomy Care Kits/Trays 4, 6, 204
 Tracheostomy Care Manikin..... 100
 Tracheostomy Holder..... 204
 Tracheostomy Mask 203
 Tracheostomy Tube Holder 204
 Training Headwall 222
 Transfer Belts..... 171
 Transparent Dressing 142
 Triangular Bandage..... 156
 Triple Antibiotic Ointment 156

TSE Model..... 114
 Tuberculin Syringe..... 213–219
 Tuning Forks 44

U

Ultrasound Gel29
 Underpads 152
 Urethral Catheter 158
 Uterus/Fetus Model 116
 Utility Basket With Mount..... 223
 Utility Cart11,12
 UV Flashlights47

V

Vacutainer Tubes77
 Vacuum Regulator..... 223
 Venipuncture Needle-Pro75
 Viewguard Dressing 142
 Vision Testing34
 Visitors Pass79
 Vistascope38
 Vital Signs Monitors 126–127

W

Walker 170
 Walking Belt..... 171
 Wall Transformer Sets.....30
 Washcloths, Disposable.....146, 152
 Wheelchairs..... 170
 Wipes146, 148
 Wound Simulation.....105, 106
 Wristbands.....79–80

Y

Yankauer 204



THREE WAYS TO ORDER:

Phone 1-847-253-3000

Fax 1-847-506-0524

Online medicalshipment.com

ROUTE TO:

- Skills Lab Coordinator
- Healthcare Educator
- Medical Training Director
- Supply Buyer



NEED A QUOTE?

MedicalShipment.com makes it easy to create a quote online!

1. Find supplies and equipment online
2. Click 'Add to Quote' to save an item
3. Fill in your shipping details
& receive a quote instantly!
(Shipping not included in quote)

It's as simple as that!

Browse our catalog, then go to
www.medicalshipment.com



Join Us
On Facebook

facebook.com/medicalshipment *Prices are subject to change.*

